



better urban lifestyle



CONTENT



01 EDITORIAL

Better urban lifestyle.

2



02 MICRO SUCCESS STORY

«Have you ever had the feeling that a distance is too far to walk but too close to get the bike or even the car out of the garage?»

9-12



03 MICROLINO STORY

How much car do you need for daily use?

13-20

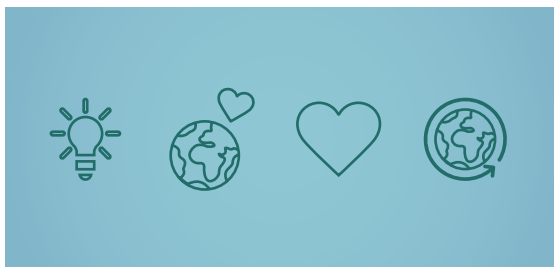

04 ABOUT MICRO

Our vision & values.

21-22



05 SUSTAINABILITY & SOCIAL RESPONSIBILITY

We are fighting throwaway society!

23-26

MICRO ECO SCOOTER & 1% FOR THE PLANET

In collaboration with 1% for the Planet, we donate 1% of the sales of our ECO product line to charitable organizations dedicated to protect the environment.

27-30

06



INNOVATION/ MICRO DESIGN LAB

Some innovate, others imitate.

31-34

07



E-SCOOTERS - THE NEW MOBILITY

The key to success? Being different!

35-36

08



ONE FAMILY, ONE BRAND

«For us, the boundaries between work and private life are fluid.»

37-38

09



MICRO COOPERATIONS

Samsung, Fendi, Mercedes-Benz, Peugeot, Mazda & Suitsupply.

39-44

10

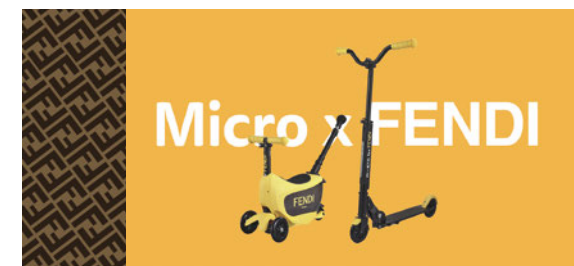

CONTENT



11 CORPORATE SCOOTERS
Environmentally friendly and space-saving mobility solutions for companies.

45-46



12 MICRO SHOPS AROUND THE WORLD
Micro products are available in over 80 countries - whether in specialist shops, online or in our flagship stores.

47-48

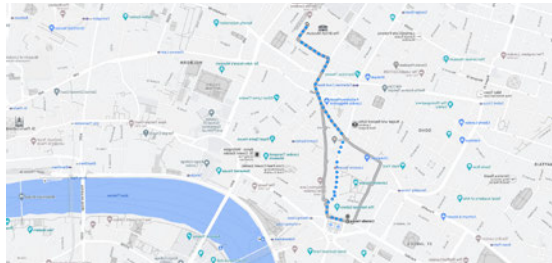

13 TIME SAVING CALCULATOR
Calculate how much time you will save if you cover the "last mile" by Micro Scooter instead of walking.

49-50

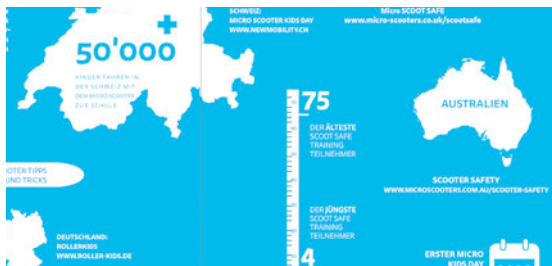

14 MICRO SCOOTER SAFETY TRAINING
Correct braking must be learned.

51-42



15 PRODUCT INNOVATIONS
We are reinventing mobility.

53-54

MICRO COMMUNITY & CELEBRITIES
Become part of the Micro Family!

55-56

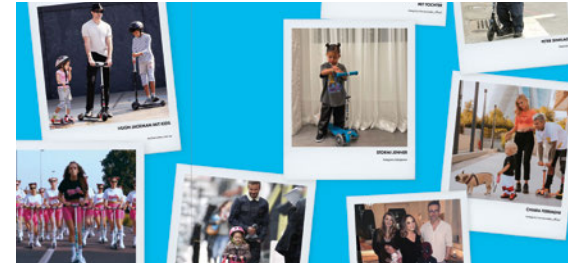

16

CHILLI
Absolute passion for stunt scooting and 100% support for the sport.

57-58



17

MICRO SKATES
Discover the inline skates product line from Micro.

59-60

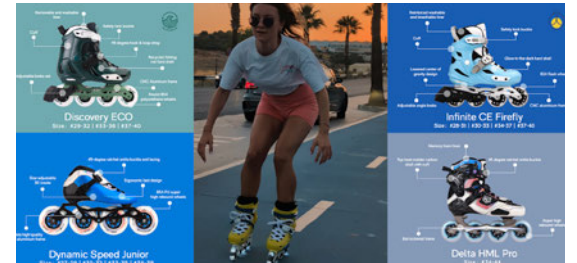

18

MICRO & INDIANA
Joining forces for the distribution of skateboards and balance boards.

61-62



19

WIM OUBOTER
In 1997, the visionary Wim Ouboter reinvented the scooter: But how does the scooter pioneer live and breathe?

63-64



20

PRODUCTS



KIDS
61



TRAVEL
223

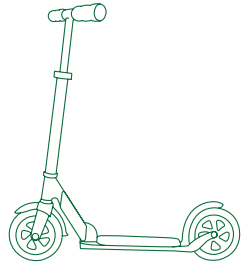
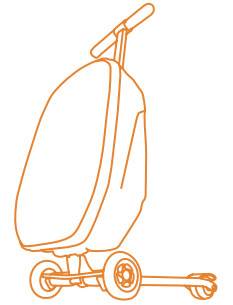

ADULTS
151

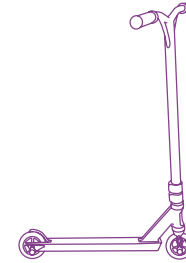

FREESTYLE
249



ELECTRIC
189

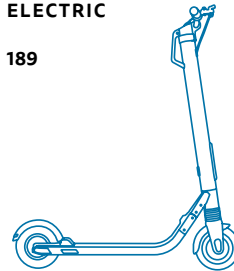

ACCESSORIES
259

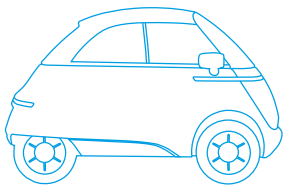

MICROLINO
211

INDEX
273





From kick scooter to
Microlino - Discover the
Micro Story as a video!

MICRO SUCCESS STORY

«Ever found yourself thinking a distance is too short to bother with the car, yet too far to walk?»

Wim Ouboter faced this same dilemma on his trips from his Zurich apartment to his favorite sausage stand, the legendary Sternengrill. Seeking a practical solution for this short, one-kilometer journey, the Swiss entrepreneur quickly invented the original kickboard. But turning his vision of micromobility into reality wasn't easy. With limited financial resources and no experience in the industry, he faced a daunting challenge: how do you successfully bring such a product to market?



Wim Ouboter with a Micro Scooter prototype



1997

Wim wanted to team up with car manufacturer Smart and equip every car trunk with a Micro Scooter. The project failed because delivery of the city cars was delayed due to technical and financial problems.



1998

After some initial stumbling blocks, Wim found a suitable sales partner in the sports brand K2. Together, they launched the three-wheeled kickboard on the market and celebrated huge sales successes.



His pronounced innovative spirit had already led Wim to a new idea: the three-wheeled kickboard. It was supposed to be easier to ride than a skateboard, but still convey the same cruiser feeling.



Wim used the income from kickboard sales to found his own company, Micro Mobility Systems AG. Now his two-wheeled Micro Scooter also made its big breakthrough. Every day, 80,000 Micro Scooters were sold, and after a year, over 30 million.

OVER 30 MILLION SALES

Just one year later, the business collapsed completely. The market was flooded with pirated copies. More than 500 factories copied Wim's Micro Scooter. A ruthless price war began.



2001

Wim's strategy: innovation. He developed the Mini Micro, a colored version of the kickboard for children. Further innovations followed and today Micro offers over 50 mobility products for children, teenagers and adults, which are successfully sold in over 80 countries.



2013

In 2013, Micro proudly presented the first E-scooter on the market, the eMicro one. This compact and lightweight electric scooter with motion control received numerous prestigious awards. The valuable experience gained in the field of electromobility since the market launch of the first eMicro one, have contributed significantly to the development of our new product line.



2015

In 2015, Wim's sons, Oliver and Merlin, started developing the electric city car Microlino. Over 36,000 reservations have been received worldwide. Series production started at the end of 2022. Today, the Microlino is taking Europe by storm.



2020

Micro was voted the 5th most innovative company in Europe by Fast Company magazine. Winners in previous years include companies such as Apple, Novartis and Spotify.



2021

Micro developed a sustainable children's scooter product line that is manufactured using recycled ocean plastic. Micro donates 1% of the sales of this ECO line to non-profit organizations dedicated to environmental protection.



2022

For over two decades, Micro has shaped the development of urban mobility with exclusive innovations. To mark the 25th anniversary of the Micro Scooter, the Swiss company revived a touch of nostalgia with the anniversary model "Micro Navigator" in a unique retro look.



2024

Micro unveils another global innovation with the Mini & Maxi Micro Glow series. These scooters feature a revolutionary design that powers their glow purely through sunlight—no batteries required.



03

MICROLINO STORY

«How much car do you really need in everyday life?»

This was the question asked by Wim, Oliver and Merlin Ouboter

Conventional cars are often too big and too heavy for the daily distances. Statistically speaking, on average only 1.2 people travel in a car for daily distances of 35 kilometers. So how should the ideal vehicle be designed for these short everyday journeys?



2015

The Ouboters realized that the perfect vehicle for everyday commuting was a mix of motorcycle and car. Such concepts already existed in the 1950s. Inspired by the old cabin cars, they created the first designs for the Microlino.

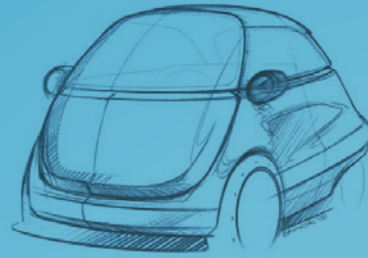

The design and technical specifications were finalized together with the Swiss University of Applied Sciences ZHAW and DW. The next step - the construction of a prototype - was realized in China in the second half of 2015.

After a few months, the time had come and the prototype arrived in Switzerland. But then something unexpected happened: the Microlino prototype fell off the forklift truck and was badly damaged.



2016

But the three founders did not give up. The vehicle was repaired in time for the Geneva Motor Show in March 2016. The efforts were more than worth it - over 500 reservations were made in just two days.

In April 2016, the Microlino team started a collaboration with Tazzari, an Italian specialist for electric vehicles. Due to the sale of the Microlino manufacturer to the German company Artega, series development has come to a standstill.



2020

In 2020, Merlin and Oliver received a spot on the "Forbes 30 under 30 Europe" list. Every year, the business magazine selects young, creative leaders and innovative entrepreneurs who have a decisive influence on the economy and society.



2021



We are delighted that the Microlino has won the Good Design Award in the "Transportation" category. The Global Design News magazine, which is part of the Chicago Athenaeum organization, has also named the Microlino Car of the Year 2021.



2022

Series production of the Microlino 2.0 started in 2022 in the newly founded Microlino Italia business unit.



- LITE -

The Microlino Lite was presented as a world first at the Paris Motor Show. This version is limited to 45 km/h, making it also accessible for those without a driver's license.



2023

On June 24, 2023, the world's first official Microlino meeting featured a standout convoy of over 70 Microlinos parading through Zurich. The event culminated in a memorable ferry ride across Lake Zurich with 54 Microlinos on board, making it a historic gathering.



Check out the aftermovie

2024

At the Paris Motor Show 2024, Micro premiered the Microlino Spiaggina, an electric cabrio that blends the charm of classic beach cars with modern mobility, offering a sustainable, open-air driving experience perfect for summer.



Spiaggina



2025

Sneak Peak: Microlino Spider Concept Launch

MICROLINO MEDIA REPORTS



The Microlino has been recognized by prestigious newspapers and blogs around the world as well as on various social media platforms in impressive articles and posts.

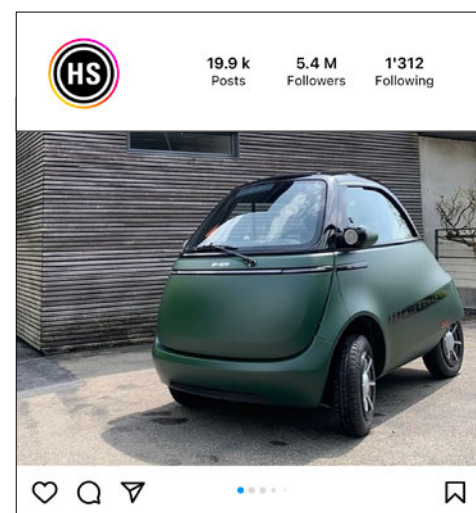
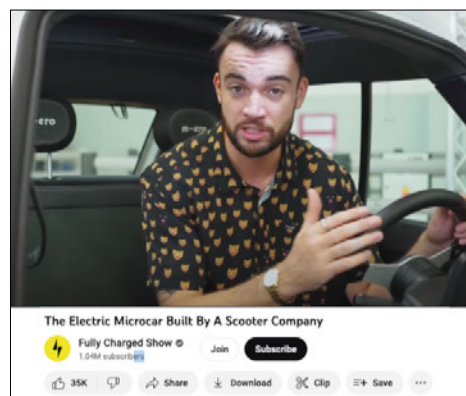
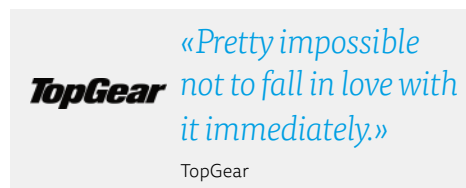

MICROLINO PRODUCTION

BORN IN SWITZERLAND - RAISED IN ITALY

Nestled in Turin, Italy—the historic heart of the Italian automotive industry—our factory is the perfect place to bring the Microlino to life. Here, on our 3,000-square-meter, solar-powered final assembly line, state-of-the-art equipment and cutting-edge systems ensure that each Microlino embodies the highest standards of quality.

facility produces components for prestigious brands like McLaren, Aston Martin, and Renault, reflecting the craftsmanship and precision that go into every Microlino.

With 50% fewer parts than a conventional car, the Microlino stands as the most sustainable option for personal mobility on the market. It blends efficiency and comfort seamlessly, providing weather protection, freedom of movement, and ample cargo space—all in a compact, stylish package. The Microlino isn't just a vehicle; it's a whole new way to navigate and experience city life.

The production process is streamlined into three key phases: Bodywork, Painting, and Assembly. At the heart of it all is the self-supporting steel and aluminum body, crafted by our esteemed partner CECOMP. This same



Microlino production and assembly line in Turin (IT)

03

MICROLINO X SWISS

HUGE IN THE AIR, TINY ON THE GROUND: SWISS OPTS FOR MICROLINOS

SWISS employees have been picking up a new way of commuting between hangar and headquarters: Instead of petrol cars, they are increasingly switching to the more efficient Microlinos. This has been made possible through a new collaboration between SWISS and the local manufacturer of electric cars Micro.

The tiny little car parked next to the imposing Boeing 777-300ER appears like a dwarf next to a giant. With its 2.5 metres in length and 1.5 metres in height, the Microlino lives up to its name. By comparison, the "Triple Seven" is 73.9 metres long and 18.5 metres high – which makes 30 times the size of a Microlino.

The image captures the start of an exciting collaboration between SWISS and Micro, marked by SWISS's purchase of three Microlinos for employee use. Beyond the striking contrast of the small Microlino beside a large aircraft, this partnership represents a meaningful step toward sustainability, as SWISS embraces energy-efficient, space-saving solutions to reduce its environmental impact.

Content from: <https://www.swiss.com/magazine/en/inside-swiss/sustainability/microlino>

Read the full article here



Instagram Video



WHY COMPANIES NEED TO ACT NOW MORE THAN EVER

At a time when many companies are scaling back or even abandoning their climate targets, the Microlino is a role model for sustainable mobility. Many companies are currently abandoning their original environmental promises, and with them the opportunity to make a real contribution to reducing global emissions. But how can we counteract this trend? The answer is simple: with solutions that are easy to implement – like the Microlino. The Microlino is not only an eye-catcher on the road, but also an effective way to drastically reduce your company's emissions. Compared to a conventional electric car, the Microlino requires around two thirds less energy in production and use.

Boost Your Business

STYLISH, EFFICIENT & FLEXIBLE – THE MICROLINO IS THE IDEAL MOBILITY SOLUTION FOR YOUR COMPANY.

Plug & Go

Plug in and charge: The Microlino is fully-charged in 4-5 hours from any normal socket.

Wow effect guaranteed

The Microlino is a real eye-catcher and puts your brand in the spotlight.

Space saver

Slim, smart and space-saving: the Microlino only takes up a third of a regular parking space.

Costs down, efficiency up

Thanks to the simple vehicle structure, the Microlino is particularly low-maintenance – minimal effort, maximum efficiency.

Green & Clean

With 60% less energy consumption than conventional electric cars, the Microlino sets new standards in terms of sustainability.



More information on how to boost your business with the Microlino

ABOUT MICRO

90 MILLION SALES

Over 90 million scooters have already been sold worldwide.

80 COUNTRIES

Micro sells its products in more than 80 countries.

80 MILLION TURN-OVER

Micro generates an annual turnover of around 80 million dollars.

100% FAMILY OWNED

The company is 100% owned by Wim Ouboter and his family.

MORE THAN 50 PRODUCTS

Micro offers over 50 mobility products for kids, teens and adults.

10'000 SALES POINTS

We sell our products in over 10'000 locations worldwide.

Our Vision

At Micro, we're passionate about making mobility more practical, sustainable and fun. **We believe that mobility is more than just getting from A to B - it's about enjoying the journey, exploring new places and moving freely however you want.** Our goal is to create innovative solutions that allow you to do just that. Whether you're commuting to work, running errands or simply spending quality time with family and friends, Micro lets you dive deep into the world of Micromobility.

But our vision goes even further: **We want to reimagine future mobility.** With our enthusiasm for innovative and high-quality Micromobility products, we are committed to bringing positive change and making sustainable mobility convenient, accessible and fun for everyone. Our pioneering spirit, deeply rooted in our family values,

drives us forward and our commitment to sustainability guides us on our journey to change the way we live and create an improved world for generations to come.



From kick scooter to Microlino: Discover the Micro story in our brand video!

Our Values

PIONEERING SPIRIT



At Micro, we are passionate pioneers of Micromobility. Our innovations, from our world-renowned foldable aluminum scooter to the Microlino, the world's smallest electric city car, are proof of this. With more than 50 ground-breaking products, we are constantly pushing the boundaries of urban mobility and creating fascination.

FAMILY VALUES



As a Swiss family business, fairness, quality, innovation and sustainability are the cornerstones of our actions. These values permeate all areas of our business, let it be the careful selection of sustainable materials for our products or the transparency of our sales processes. They are also reflected in our commitment as an employer and an active part of society.

PLANET FRIENDLY



We are deeply convinced that sustainable mobility is shaping the future. Our commitment to sustainability is global and is reflected in numerous local initiatives. Our passion for high-quality and sustainable mobility solutions drives us and contributes to creating a better urban lifestyle.

BUILT TO LAST



Our products are not only stylish, but also designed to last. Thanks to interchangeable parts, Micro products can be used by several generations. In addition, we offer worldwide repair and spare parts services to minimize our environmental impact. We invest in quality and durability, helping to create a more sustainable future.



Find out more about our sustainability efforts at www.micro-mobility.com

We are fighting throwaway society!

SUSTAINABILITY & SOCIAL RESPONSIBILITY

QUALITY AND SAFETY ARE OUR TOP PRIORITIES

Our products are characterized by exceptionally high quality and durability. We only use carefully selected raw materials. New products undergo a strict quality control system with various test procedures at every stage of development and production. This ensures that all requirements of national and international safety standards are met.



UNBELIEVABLE BUT TRUE: THIS MICRO SCOOTER IS 22 YEARS OLD!

A customer in the Czech Republic inherited the scooter from his father and is planning to replace the wheels and handles so that his son can ride it. He is delighted with the longevity and quality of the scooter and has no plans to buy a new one.



WE ARE REDUCING OUR ECOLOGICAL FOOTPRINT

We are constantly striving to optimize our product range and the entire Micro value chain and make them more sustainable. Among other things, recycling and the reduction of plastics in our products and packaging is a high priority. We are also gradually increasing the use of FSC-certified paper for our packaging.



EVEN A DUTCH BRIDGE CANNOT AFFECT THE QUALITY OF OUR SCOOTERS!

During a family vacation in the Netherlands, fascinated tourists marveled at the lifting bridge in Maastricht. They did not notice how the bridge closed and trapped their child's Micro Scooter. After about half an hour, the bridge lifted again and the scooter was freed without damage.

Repairing instead of throwing away

Contrary to today's throwaway society, Micro products are made for a long life. We offer a unique worldwide repair and spare parts service for every product. Our own global sales and service network guarantees the professional maintenance of our products, which has a positive impact on their lifespan and protects resources.

OUR PRODUCTS HAVE AN ABOVE-AVERAGE LIFESPAN

The handlebars of our kids products are height-adjustable and grow with the user – from the first steps to pre-school age. A Micro Mini2Grow, for example, is used for an average of six years. Compared to a McDonald's toy, which is only used for a few hours at most, or a Barbie doll, which the child plays with for a year at best, this figure is considerable. Additionally, with our products, kids go outside in the fresh air, which promotes physical health and development.



We want to bring about a change in society!

OUR STRATEGY: PRIVATE E-SCOOTERS INSTEAD OF RENTAL SCOOTERS

The behavior of road users has changed: people are using more and, in particular, different means of transport on their journeys. As the inventors of Micromobility, we have been convinced for over 25 years that a scooter is the ideal means of transportation for cities - light, compact, safe and sustainable! Contrary to developments in the field of free-float E-scooter sharing, we are pursuing the strategy of personal electric scooters. In our opinion, the business model originating in the USA is neither sustainable nor safe. A study

published by ETH in January 2022 shows that privately owned E-scooters, in contrast to sharing offers, actually improve the ecological balance.* Owning your own E-scooter means taking responsibility for its condition and handling. Thanks to their low weight and easy foldability, our E-scooters can easily be taken into the home or office and combined with public transport. It is also dangerous to use E-scooters in busy city centers without any training.

I  MY OWN E-SCOOTER

* <https://www.sciencedirect.com/science/article/pii/S1361920921004296>



Microlino vs. Cybertruck

WE REINVEST 80% OF OUR PROFITS IN THE DEVELOPMENT OF SUSTAINABLE MOBILITY SOLUTIONS

Twenty-five years ago, Swiss visionary and pioneer Wim Ouboter transformed urban transportation with the Micro Scooter, paving the way for today's micromobility movement.

Now, with the Microlino, he's set on elevating his vision of sustainable, space-saving urban mobility to new heights—joined by his sons, Merlin and Oliver, in this mission.



2491.2 kg CO₂ saved over 1 year



4.34 Years heating of a 1.5 room apartment

DRIVE ECO



19.93 Flights from London to Paris



0.01 Flights to the Moon

Annual CO₂ savings compared to a gasoline powered car*

EFFICIENCY BEAST MICROLINO

The Microlino not only impresses with its cuddly appearance, but is also extremely environmentally friendly! Compared with an annual journey of 15,000 kilometers in a petrol car, the Microlino can save 2,491 kg of CO₂. This is equivalent to 20 flights from

London to Paris or 0.01 flights to the moon and back. Due to its light weight, the Microlino consumes around 60% less energy than a conventional electric car.

Calculate your annual CO₂ savings with the Microlino.



* Assumption: 15,000 km per year

EXPLORING TODAY PROTECTING TOMORROW

MICRO ECO PRODUCT LINE

Approximately 10% of the plastic waste in our oceans comes from abandoned fishing gear, with an estimated 640,000 tons of nets and equipment left behind each year. Our sustainable Micro Kids Scooters are part of the solution, incorporating recycled materials sourced from collected ocean waste. The ECO product line marks a significant step forward in our commitment to sustainability. For over 25 years, we have crafted durable products designed to be passed down through generations, and we're continuously expanding our ambitious sustainability goals to make a lasting impact on the environment.

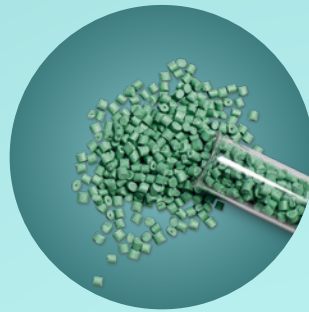

06



PARLEY

Micro donates 1% of its
ECO product line sales
to charitable organizations.



MICRO IS A PROUD MEMBER OF 1% FOR THE PLANET

In partnership with 1% for the Planet, we donate one percent of the sales of our ECO product line to non-profit organizations dedicated to protecting the environment. Proceeds from **Micro support Parley's educational programs to provide global access to ocean**

education, tools and experiences, promote ocean conservation and support a network of leaders called Ocean Guardians. Learn more about Parley and their mission at www.parley.tv.

«We recognize that the challenges facing our world are too great for one person or one organization to solve alone. Companies like us have an even greater obligation to help. Our partnership with 1% for the Planet is another step in the right direction.»

Wim Ouboter, Micro Founder & CEO

eco

8 Million
tons of plastic waste end up
in our oceans every year.

Plastic Pollution
is the most widespread problem
affecting the marine environment.

11%
of it stems from the
maritime industry.

We recycle
fishing nets, ropes and trawls into
Micro Scooters.

Benefits
reducing landfilling
reducing marine pollution
reducing loss of valuable
resources.





MICRO X RIGHT TO PLAY

Through the "1% for the Planet" initiative, Micro donates one percent of sales from the ECO Kids Scooter product line to charitable organizations. Proceeds donated by Micro support Right To Play in their mission to protect, educate and empower children to rise above adversity through the power of play.



ABOUT RIGHT TO PLAY

Right To Play protects, educates, and empowers children to rise above adversity using the power of play. For 25 years, they have been a global leader in helping children learn and improve their well-being through play – one of the most fundamental forces in a child's life. They reach millions of children each year in some of the most difficult places on earth,

helping them to stay in school and graduate, resist exploitation, overcome prejudice, heal from trauma, and develop the skills they need to thrive.

Learn more:
www.righttoplay.com / www.righttoplay.ch



Right To Play's Impact

In 2023, Right To Play made a significant difference in the lives of millions of children and young people through its play-based programs designed to foster learning and well-being. The organization reached 5.6 million children worldwide, both directly and through partner-led initiatives, with nearly half of the participants (49%) being girls.

87'552 REFUGEE CHILDREN in 93 refugee camps and internally displaced person-settlements.

15'913 YOUNG PEOPLE including more than 4,800 Junior Leaders who gained skills to support their peers.

111'350 PARENTS & CAREGIVERS with programs that empowered them to protect children and support their learning.

149'189 EDUCATORS & COACHES with training that equipped them to support children's learning and well-being.



INNOVATION

SOME INNOVATE, OTHERS IMITATE.

For over 25 years, Micro has been shaping the development of urban mobility with exclusive innovations. Starting with the world famous Micro Scooter, to the revolutionary Scooter Luggage, a suitcase with a fold-out kickboard, to the latest coup, the Microlino the electric city car.



«Innovation is our passion!»

Since Micro Mobility Systems was founded, innovation has been a major part of the company's DNA. True to the vision of a "better urban lifestyle", Micro now offers over 50 different mobility products for kids, teens and adults and is the global market leader in the premium segment. The spectrum ranges from the popular children's scooter to stylish electric scooters and the latest coup, the Microlino. The heart of this tireless innovation process is the Micro Design Lab in Küsnacht ZH - this is where new ideas are tinkered with and the first prototypes are created with passion and dedication.

In this interview, Yannick Lissanda, Head of Micro Design Lab, tells us where he gets his inspiration for new products and what makes Micro's product design unique. Your story - how you came to Micro - is a rather unconventional one. Why don't you tell us ...



Yannick Lissanda, Head of Micro Design Lab

After completing my Bachelor's degree in Industrial Design in Lausanne, I gained my first professional experience at "greutmann bolzern designstudio". I then worked for Adidas for two years and also worked as a freelance product designer on various projects. I have been an enthusiastic Micro fan since I was 12 years old. I used to do my weekly shopping with the Micro Flex. One day I had the idea that it would be much more practical if I could attach my shopping bags to the scooter instead of having to ride home one-handed. So I built a prototype and wrote an e-mail to Micro. Then everything happened very quickly: after two exciting conversations, I started as a Product Designer at Micro. I've now been here for 7 years and head up the Micro Design Lab.

Where do you get the ideas and inspiration for new products?

Curiosity and observation are the be-all and end-all. People and nature are my greatest inspiration. And when I'm wearing my favorite grey sweater and have my hood up, my colleagues in the office also know that my head is spinning and I'm "brainstorming" new ideas. It's best not to disturb me then.

«If I don't get any further, I go to the place where the product will later be used. The ideas then come all by themselves.»

«Micro's product design is characterized by a certain simplicity and durability.»

What is the biggest challenge when designing a new product?

Expectations.

From whom?

The difficulty lies in doing justice to all the different parties. I hear from the management: "That's too expensive." From the engineers: "It won't last, it won't work like that." From marketing: "That doesn't suit our image." Then there are the sales people, the factory and, of course, the customers, who are ultimately the most important. I want to satisfy all these groups, which is not always easy.

What characterizes Micro's product design?

The Mini Micro, for example, has a timeless design that lives on over the years and always finds its target group without having to change much. This is by no means a matter of course, especially in the scooter sector, as the market is changing very quickly.

What role does sustainability play?

We select the best materials for each project, we test our products according to international standards so that they last as long as possible, we only use as much material as necessary and no more and, finally, we are constantly looking for new, more environmentally friendly materials and production processes. So you could say that sustainability plays a very central role. But it is also important to mention that we need the support of our customers, who also play their part by making conscious purchasing decisions.



Yannick Lissanda and Roberto Sonza, Micro Design Lab

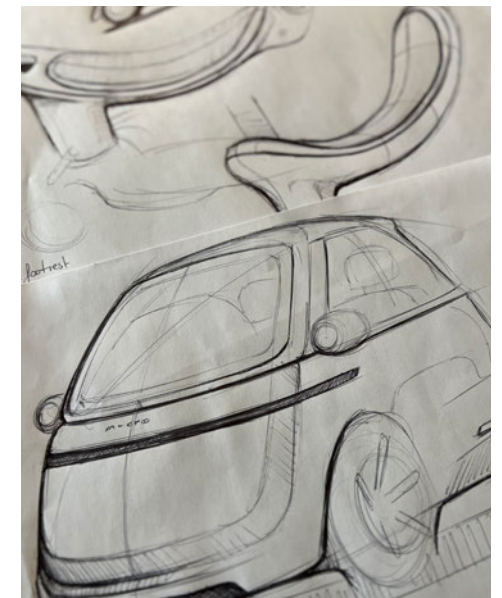

Product sketches of the Mini2Grow & Microlino

THREE CATEGORIES OF MICROMOBILITY

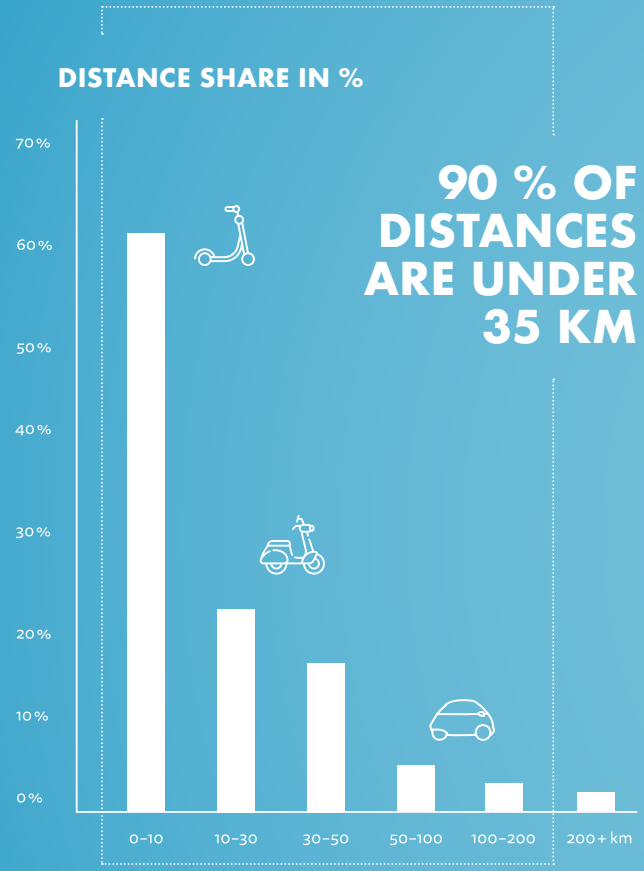

Consider this: When was the last time you drove over 200 km in a single day? How often do you carry more than two passengers in your car? For 95% of trips, micromobility is the more efficient choice. But there's no one-size-fits-all solution—needs vary.

Some people live near city centers and benefit from small, compact transportation, while others reside in less connected suburbs or colder climates. Regardless of the situation, finding environmentally friendly, space-saving mobility solutions without compromising comfort is key. That's why we've created three categories of micromobility. Which one fits your lifestyle best?



E-SCOOTER & E-BIKE

Ideal for short distances of up to 30 km and in combination with public transport.



MICROLETTA

Ideal for medium distances of up to 100 km and for weaving your way through traffic.



MICROLINO

Ideal for riding medium to long distances of up to 200 km.

WHAT IS THE FUTURE OF E-SCOOTERS?



From their beginnings as shared mobility solutions, E-scooters have evolved beyond reliance on sharing platforms. While sharing services played a pivotal role in popularizing E-scooters globally and normalizing them as a mode of transportation, the landscape is shifting. More and more users are recognizing the value of owning an E-scooter—it's not only cost-effective but also a more sustainable choice. E-scooters are emerging as a smart alternative to bicycles and E-bikes, offering unparalleled convenience. And who knows—one day, teaching our children to ride an E-scooter could become as natural as teaching them to ride a bike.

RETHINKING THE E-SCOOTER BUSINESS MODEL

The challenge is no longer about proving the benefits of E-scooters—one short ride is enough to experience their freedom and practicality. The real opportunity lies in convincing companies, universities, cities, and public transit systems that micromobility is a vital addition to their offerings. In a rapidly evolving industry, where competitors are still defining their place, true success will come from standing out. At Micro, we believe in being different—truly different—because that's what it takes to lead the way into the future of urban mobility.



ONE FAMILY, ONE BRAND

Who does what in the company?

Wim: My boys, Oliver and Merlin, manage the Microlino project and the Micro marketing team. My wife Janine is the head of finance and looks after the figures. As the founder, I'm mainly involved in the strategic side of Micro and Microlino, but I also like to get involved in product development.

«For us, the borders between work and private life are fluid.»

What are the advantages and disadvantages of the whole family working in the same company?

Janine: For us, the boundaries between work and private life are fluid. Business topics are often discussed during dinner. Depending on the situation, this can sometimes get louder with our two hotheads Wim and Merlin. I often mediate between the two so that we can end the evening peacefully on the sofa.

Oliver and Merlin, how long have you been involved in the company?

Oliver: Ever since we were children, we were the first guinea pigs for all new Micro products. We learned a lot about the company at a young age and our parents always took our opinions seriously. At school, when the freestyle scene came up, we started selling trick scooters from our workshop. With the

Microlino we want to take Micro one step further – from two to four-wheeled mobility products.

What have you learned from your parents and what have they learned from you?

Merlin: I think we learned a lot about entrepreneurship and management from our parents. They always met us as equals –

despite the age difference. For me, this is the secret ingredient for a successful family business. On the other hand, they learn from us how the younger generation sometimes solves problems in a different way. The Microlino team is a relatively young team, but at the end of the day it needs the same leadership qualities as it did 25 years ago.

«They always took us seriously, independently of our age.»



MICRO COOPERATIONS

FENDI

Elegance on wheels

The two renowned brands, Micro and Fendi, share a passion for quality, exclusive design and innovation. Together, they launched two limited-edition kids' scooters on the market in February 2021.

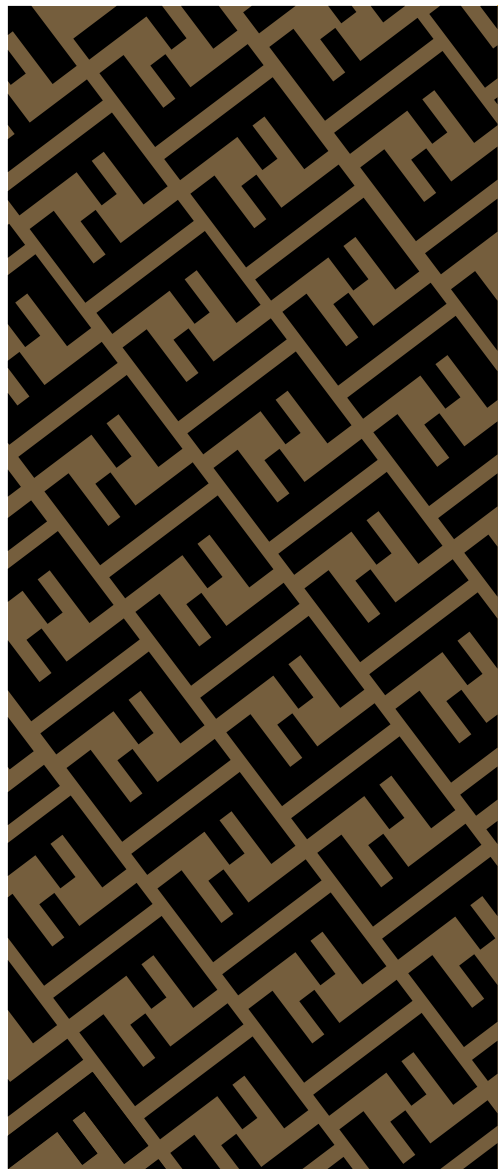

Micro for FENDI Kids Scooter



Micro for FENDI Adult Scooter

10



Zero emissions on the last mile with the new Mercedes-AMG E-scooter

MERCEDES-BENZ

Innovative mobility solutions will significantly improve the quality of life in cities. The Micro X Mercedes-AMG E-scooter is an emission-free solution for mobility on the so-called "last mile". Additionally, Mercedes-Benz offers co-branded Micro products for children in exclusive Mercedes-Benz design, combining style and functionality, as well as an innovative scooter-luggage hybrid for on-the-go convenience.



MICRO X MERCEDES-AMG E-SCOOTER



MERCEDES-BENZ MINI2GROW

MERCEDES-BENZ SCOOTER LUGGAGE

Dutch menswear label meets Swiss kickboard pioneer

SUITSUPPLY

The search for the unconventional has brought the two successful brands together - the result: a unique piece of luggage on wheels. The Race Case with its Italian calfskin finish and smooth textured surface is guaranteed to leave a lasting impression as you approach the check-in counter.



SUITSUPPLY TRAVEL SCOOTER

Focus on innovation

MAZDA

In collaboration with the Japanese car manufacturer Mazda, the Swiss family business Micro has developed a stylish, compact and handy E-scooter for the last mile. The Micro Commuter weighs just 10 kilograms and is particularly ideal for commuters and short-distance riders who value high portability. Thanks to its intuitive folding mechanism, the E-scooter can be folded up in seconds and easily stowed in the trunk or transported on public transport.



MAZDA E-SCOOTER

Delights not only presidents

PEUGEOT

By integrating the Peugeot Micro e-Kick into the trunk of the 3008 SUV, Peugeot and Micro are pursuing a joint urban mobility strategy. The two lifestyle products also form a purist and elegant unit in terms of design. Incidentally, it was the former French President, François Hollande, who was the first to take a look at the world premiere of the hybrid E-scooter at the 2016 Paris Motor Show - he was impressed.



PEUGEOT E-KICK



More information on the Micro website

MICRO X SAMSUNG

MICRO AND SAMSUNG SWITZERLAND PRESENT:

Mini Micro Deluxe Glow LED! Experience the perfect symbiosis of mobility and technology! The new Mini Micro Deluxe Glow LED not only offers children illuminated elements for

greater safety, but also an integrated location tracker, the Samsung Galaxy SmartTag2. This makes finding the scooter again child's play.

EASY TO FIND VIA APP

Thanks to the integrated Samsung Galaxy SmartTag2 in the footboard of the Micro Scooter, locating your scooter is now effortless. Misplaced, forgotten, or mistakenly taken? No problem! The convenient app makes finding it quick and easy.



Watch the video on Youtube!

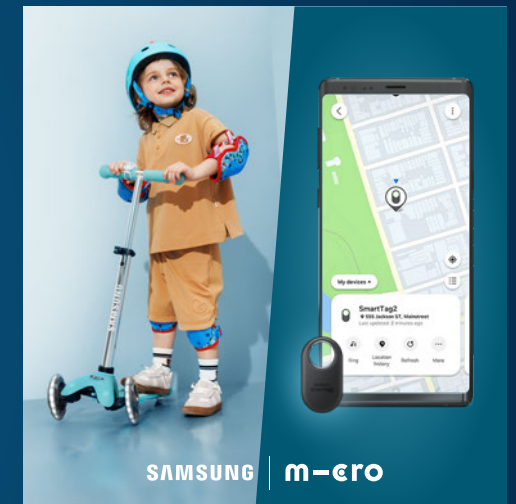

Integrated Galaxy SmartTag2
Tag it. Find it.

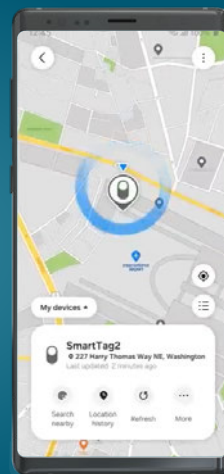

MAGICAL DRIVING EXPERIENCE FOR CHILDREN

Enjoy a truly enchanting ride with LED wheels and sunlight-activated light elements on the footboard, handles, and brake. These features don't just add a touch of magic—they also provide outstanding visibility and safety in all lighting conditions.

CORPORATE SCOOTER

Environmentally friendly and space-saving mobility solutions for companies, hotels & events

A growing number of companies are investing in advanced mobility solutions offering both employees and customers optimal transportation options. These solutions serve different purposes - as practical means of transportation between different company locations, as environmentally friendly alternative to company cars or as a unique experience for guests.



TRAVEL AND EXPLORE

Micro Kickboard USA has entered into an exclusive partnership with Kimpton Hotels & Restaurants, a renowned boutique hotel chain with 74 locations worldwide. The Kimpton team worked with Micro to develop customized Mini Deluxe and Maxi Deluxe Scooters, which are now available to hotel guests at 30 selected locations in the US.



GOOGLE

©: Limmattaler Zeitung

Google provides its employees in Zurich with around 200 branded Micro Scooters for commuting around the company premises and for lunch outings.



KIMPTON HOTELS & RESTAURANTS



11

MICRO X EXPO DUBAI

As an official supplier, we were able to equip the Swiss pavilion at Expo Dubai with 100 branded Micro Scooters and a Microlino.

25hours hotels

25HOURS HOTELS

At the "25hours Hotel Zurich West", hotel guests can rent cars, bicycles and Micro E-scooters. The mobility concept is an opportunity to meet the needs of urban, cosmopolitan travelers.



WattWorld

WATTWORLD SHARING

Docking station with E-scooters, which can be unlocked via app or company card, for traveling between the various company locations.



MICRO SHOPS AROUND THE WORLD

12



JOHN LEWIS, OXFORD ST, LONDON UK



POPUP STORE, LA, USA



MICRO IN THE MUMBAI DUTY FREE



MICRO STORE, AMSTERDAM



SHINSEGAE DEPARTMENT STORE, GANGNAM, KOREA



MICRO MOVING STORE, ECUADOR



DUFREY, ANECDOTE, ZÜRICH AIRPORT, SWITZERLAND



YOUNG V&A MUSEUM DISPLAY, LONDON, UK



MICRO FLAGSHIP STORE, ZURICH, SWITZERLAND



STARFIELD GOYANG, KOREA

Micro products are available in over 80 countries - whether in specialist shops, online or in our flagship stores. Our sales partners around the globe do everything they can to implement our vision of a "better urban lifestyle" and the associated Micromobility concept at the point of sale in line with market requirements. We are proud how all our partners always represent Micro as a brand with full vigor and enthusiasm.

*Many thanks to all
Micro partners!*

MICRO DEALER SEARCH



www.micro-mobility.com/en/dealer-locator

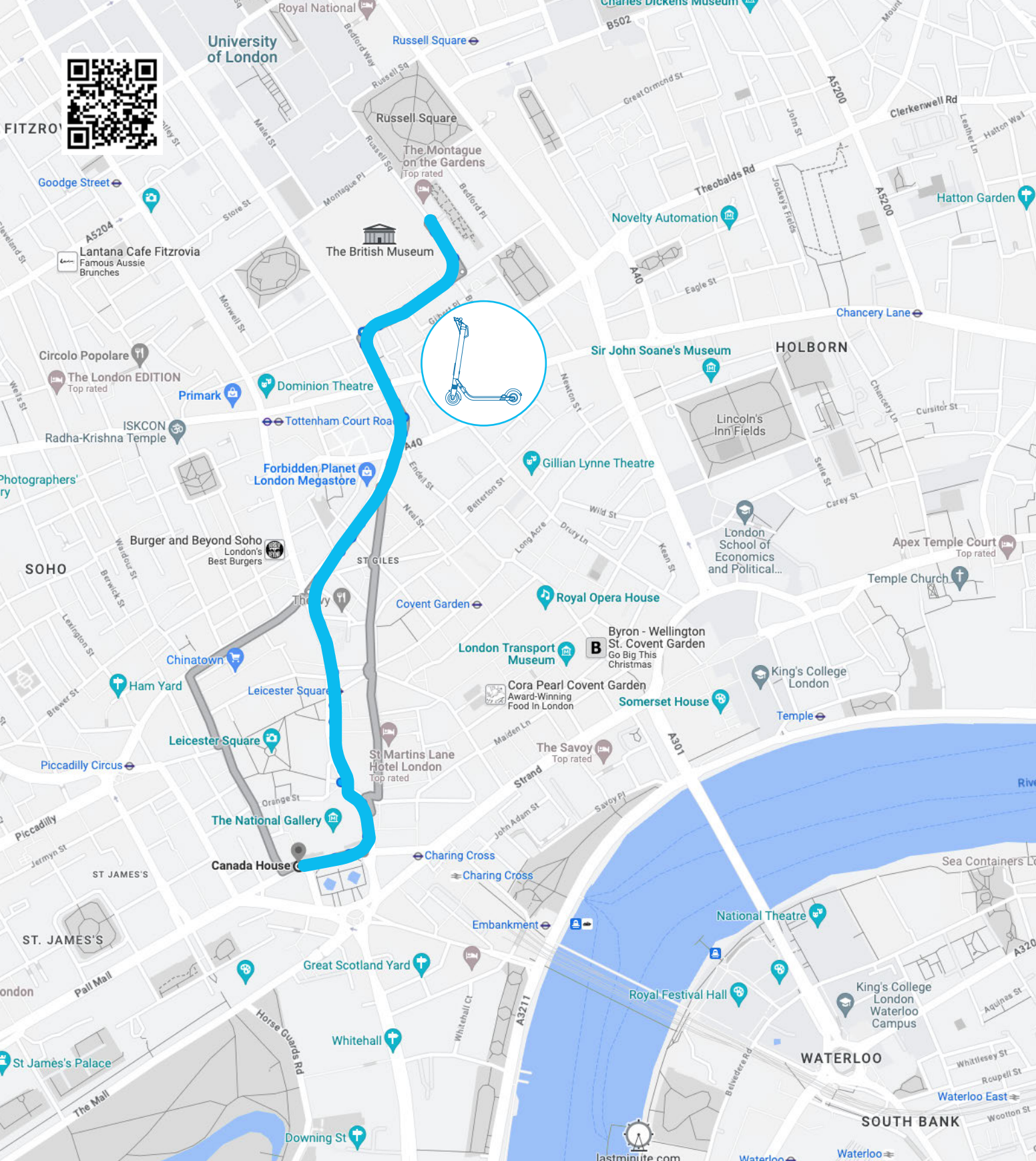

13







TIME SAVING CALCULATOR

Time is precious!

The time saving calculator on micro-mobility.com calculates how much time you save if you travel the "last mile" by Micro Scooter instead of walking.



ZURICH: BELLEVUE - ZURICH ZOO

-  19 Films
-  3 Books
-  25 Fitness trainings
-  148 Beers with friends
-  19 Yoga classes
-  74 Dinners

1.52 DAYS 12 HOURS PER YEAR • 720 MINUTES PER YEAR

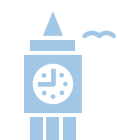

LONDON: BIG BEN - BUCKINGHAM PALACE

-  25 Films
-  4 Books
-  33 Fitness trainings
-  196 Beers with friends
-  25 Yoga classes
-  98 Dinners

2.21 DAYS 49 HOURS PER YEAR • 2940 MINUTES PER YEAR

MICRO SCOOTER SAFETY TRAINING

«That was the coolest morning since I started school! Now I finally know how to brake properly!»

Correct braking needs to be learned. This is why Micro supports safety courses for scooters and kickboards worldwide. In addition to the correct braking technique and safe cornering, the workshops also raise understanding and awareness of the dangers and rules when using these popular means of transportation.



Workshops since 2008



520'000



OVER HALF A MILLION ENTHUSIASTIC PARTICIPANTS WORLDWIDE

Switzerland:
Micro Scooter KIDS DAY

Micro SCOOT SAFE
www.micro-scooters.co.uk/welcome-to-scootsafe

EACH LESSON
LASTS 90 MINUTES



SCOOTER TIPS
AND TRICKS

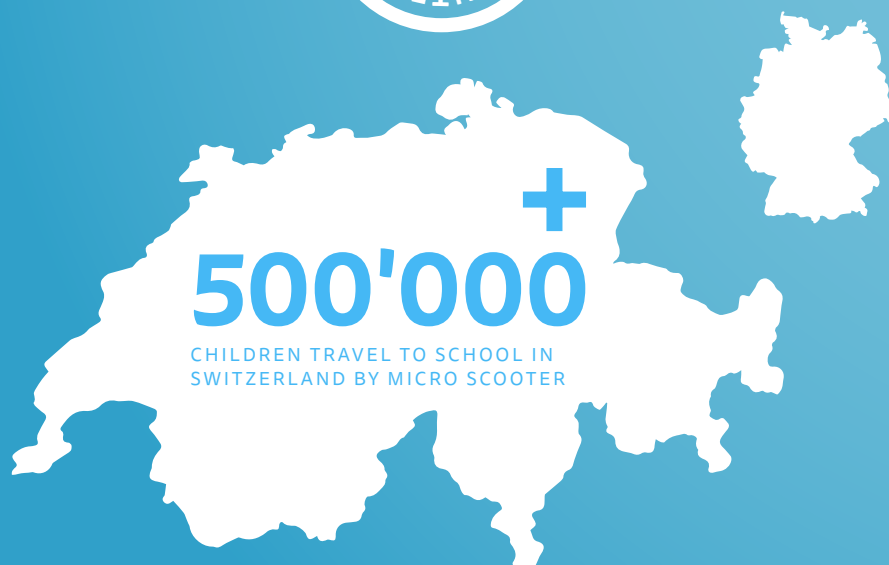

GERMANY: ROLLERKIDS
WWW.ROLLER-KIDS.DE

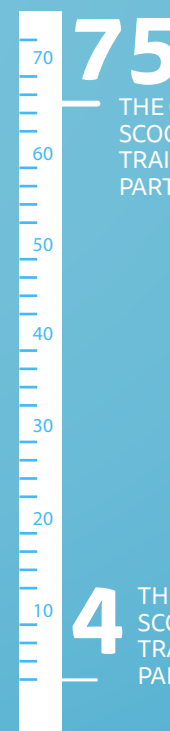

75
THE OLDEST
SCOOTER SAFETY
TRAINING
PARTICIPANT

SCOOTER SAFETY
WWW.MICROSCOOTERS.COM.AU/SCOOTER-SAFETY



4
THE YOUNGEST
SCOOTER SAFETY
TRAINING
PARTICIPANT

FIRST MICRO
KIDS DAY



PRODUCT INNOVATIONS

15



MICRO AIR HOPPER 2



MICRO KICKPACK LITE



MICRO KICKBOARD RELOADED



MINI MICRO DELUXE ROCK & SCOOT

1 YEARS → 6+ YEARS
Grows with your child.

WE ARE REINVENTING MOBILITY

Since the foundation of Micro Mobility Systems innovation has been a major part of our corporate DNA. True to our vision of a "better urban lifestyle", we now offer over 50 different mobility products for children, teens and adults and have established ourselves as the

global market leader in the premium segment. Every year, we launch five to seven new products, often breaking new grounds. As a result, we are always one step ahead of our competitors.



MINI MICRO DELUXE GLOW LED PLUS



MICRO SCOOTER LUGGAGE JUNIOR



MICRO MINI2GROW DELUXE MAGIC LED



MICRO SUBURB RELOADED



MICRO TRICYCLE



MICRO SPRITE ECO LED

MICRO COMMUNITY & CELEBRITIES

BECOME PART OF THE MICRO FAMILY!

Space-saving and environmentally friendly Micro Mobility or simply "better urban lifestyle" – is our vision. But a vision is worthless without people who believe in it and drive it forward. We are therefore all the happier that our community is growing from day to day. Over 500,000 fans worldwide have already used the hashtag #microscooter #microscooter AND have already, how they live their "better urban lifestyle".

#microscooter



CHRISTIAN BALE AND FAMILY
Daily Mail UK



SARAH JESSICA PARKER WITH KIDS
Daily Mail UK



JADEN SMITH
Okavli/REX/Shutterstock



GWEN STEFANI & ANGELINA JOLIE WITH KIDS
www.20.com



ALESSANDRA AMBROSIO WITH DAUGHTER
Instagram/microscooter_official



PETER DINKLAGE
Daily Mail UK



ROMEЕ STRIJD WITH KIDS
microscooter.com.au



DAUGHTER OF KYLIE JENNER STORMI JENNER
Instagram/kylijenner



SON OF KIM KARDASHIAN PSALM WEST
Instagram / kimkardashian



HUGH JACKMAN WITH KIDS
microscooter.com.au



CHIARA FERRAGNI
Instagram/microscooter_official



JASON STATHAM
Weeeg.com



TATUM (SON OF KHLŌE KARDASHIAN)
microscooter.com.au



CHADIA RODRIGUEZ
www.youube.com



LUCAS DI GRASSI
Instagram / lucasdigrassi



DAVID BECKHAM WITH DAUGHTER
Fame.lynet.uk.com



MARIAH CAREY
Instagram/microscooter_official



17



CHILLI

KEEP ON RIDING TEAM CHILLI

Chilli Pro Scooter is proud to continue expanding its presence within the global stunt scooter community. Over the past year, our riders have achieved outstanding results at international competitions, including the prestigious FISE event in Montpellier, where rising star Neve Entwistle secured first place in the Women’s Park category. This milestone not only highlights our riders’ talent but also solidifies our partnership with World Skate, the organization that successfully brought skateboarding to the Olympics. Through this collaboration, we hosted the “King of Germany” competition, showcasing and ranking the nation’s top talent.

In another significant step forward, we’ve partnered with DRIV – the German Roller Sports Association – which has officially recognized stunt scooting as a legitimate sport in Germany. This recognition marks a pivotal moment for the sport and its future growth.

Our distribution partners are also playing a crucial role in elevating the brand. A stand-

out example is our U.S. partner, who recently launched a product tailored specifically for street riders in sunny California. This product, designed and developed in the U.S., highlights our commitment to innovation and localization.

Understanding the needs of diverse rider segments remains at the heart of our mission. By introducing new product categories, we aim to offer a complete range that supports every stage of the rider’s journey — from beginners just starting out to seasoned athletes refining their skills.

As stunt scooting continues to grow in popularity—thanks to its accessibility and the perfect balance of ease and challenge — it’s attracting an ever-wider audience. So, keep riding with us, and together, we’ll push the sport to new heights.

-  @ChilliScooterTV
-  @chilliscootersglobal
-  @chilliproscooter
-  www.chilli-proscooter.com



18

Micro Skates

In addition to the successful scooter and kick-board business, we have developed into one of the best-known and most popular inline skate brands in the world. The range includes inline skates and ice skates for all age groups, from beginners to professional models. We also develop accessories such as ice skate bags, clothing and care products. In collaboration with inline skate world champions and top influencers, Micro Skates regularly brings new product innovations onto the market and thereby raises the profile.

www.micro-skate.com

 @micro.skate
  Micro Skate
  @MicroSkate



Faustina Busto on the new 2023 Micro Delta X Freestyle Inline Skates:

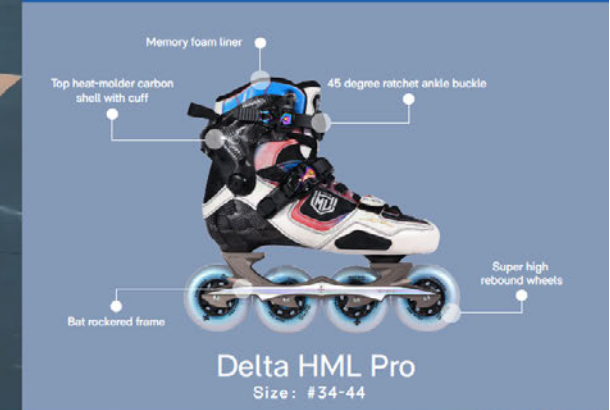

Micro & Indiana

UNITED FORCES FOR THE DISTRIBUTION OF SKATEBOARDS AND BALANCE BOARDS

Scooter pioneer Micro and the renowned skateboard brand Indiana joined forces in 2023 to internationally promote product development, distribution and marketing of Indiana Skateboards and Balance Boards. The basis of this collaboration is the long-standing friendship between Micro inventor Wim Ouboter and Indiana founder Christof Peller, who both grew up near Lake Zürich. **With over 50 years of combined experience in scooter and board sports, they share a vision - to create a sustainable "last mile of mobility".**

Micro revolutionized urban transportation 25 years ago with the globally successful Micro Scooter. Christof Peller, a passionate board athlete, was one of the first to use snowboard technology for surfing on asphalt. Indiana's skateboards are known for their purist design and were exported to Japan, where they achieved world championship titles and cult status. The balance boards, developed as entertaining sports equipment to promote balance and coordination, complement Indiana's range. Both



companies share important values such as sustainability, innovative spirit and commitment to product quality. Indiana products will continue to be sold under the existing brand name and produced in Europe. Indiana can benefit from Micro's global distribution network in over 80 countries to continue its growth path.

"With our many years of experience in the field of urban mobility and the knowledge of Indiana, we are able to offer our customers a broader range of sustainable and high-quality products," says Micro founder and CEO Wim Ouboter. Christof Peller, founder of Indiana, adds: "We are proud to work with Micro and bring our products to a wider audience."



WIM OUBOTER AKA MR. KICKBOARD

In 1997, the pioneer and visionary Wim Ouboter reinvented the scooter: his Micro Scooter became a global success and has been an integral part of the world's metropolises ever since. Today, the Swiss entrepreneur is at the forefront of the e-mobility wave and is revolutionizing with his two sons, Oliver and Merlin, the urban mobility of the future. But how does the scooter pioneer live and breathe?



LIFE

- Biggest weakness?**
Dyslexia
- Greatest strength?**
Also dyslexia
- Dream vacation?**
On the island of Paros in Greece
- Favorite hobby?**
Wing foiling
- Morning person or night owl?**
Morning person
- I do this first thing in the morning...**
Bringing my wife, Janine, a cup of tea to bed
- Doesn't work at all?**
SUVs in the city
- Greatest pride?**
My two sons

THINGS I LOVE

- Books?**
The Innovator's Dilemma by Clayton Christensen
- Movie?**
Once Upon a Time in America
- Music?**
Coldplay
- Dish?**
Bulgogi



THE MICRO REVOLUTION

The origin story of a global brand, told by Micro founder & scooter pioneer Wim Ouboter.



DOWNLOAD THE BOOK!



THE SOURCE OF MANY CHILDHOOD MEMORIES

Countless kids all over the world grew up with our scooters, riding them on the way to kindergarten, in the schoolyard or in their free time. Our kids products have successfully maintained their strong market position for many years and have won several international awards. They are also recommended by doctors. Although Micro products are often copied when it comes to quality, no one can beat them. But what makes us the happiest is that we have managed to bring a smile to the faces of millions of children and parents.





MICRO AIR HOPPER 2

Bounce and ride - in a new design!

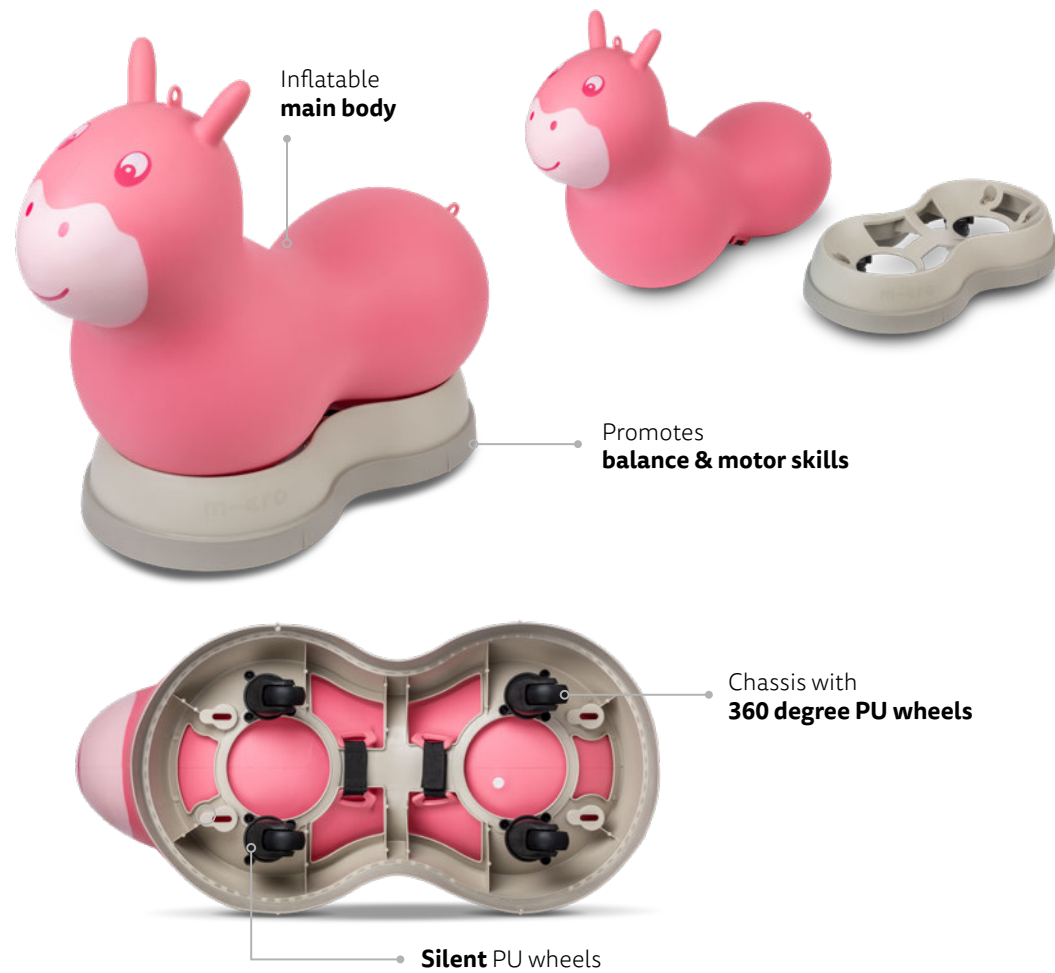
- Moka HP0005
- Aqua HP0007
- Pink HP0006
- Blue HP0004



- 18+ Months** 
- 2.4 kg** 
- 25 kg** 



Check it out on YouTube 

MINI MICROLINO

The mini version of the popular Microlino

- Blue MC0001
- Mint MC0002
- Pink MC0003



Storage space for toys



Reflector



Self-propelled ride-on vehicle driven by rhythmic handlebar movements

Low seat height for stability and tipping safety

Foam padded seat

Shining headlights



Guaranteed fun indoors and outdoors

Unique Microlino design

18+ Months

4.3 kg

50 kg



Check it out on YouTube



MINI MICRO DELUXE ROCK & SCOOT LED

From rocking to rolling - grows with your child!

Customizable Comfort:

4 Seat height options. Adjustable seat and handlebars ensure a perfect fit as your child grows.



Rock & Scoot Fun:

Enjoy smooth rocking and riding modes in one versatile product.

Lightweight Stability:

Easy to maneuver yet sturdy enough to keep your child safe at every stage.



6-in-1 Functionality:
One product, six setups—designed to grow with your child from 1 to 6+ years.



Grows with your child.

Image is for reference only and may change at any time.

- Olive Sage MMD0385
- Lavender Mist MMD0387
- Dusty Rose MMD0386
- Ocean Slate MMD0388

No Tools Needed:

Effortlessly transform between stages with a simple, tool-free setup.

Perfect for shared adventure:

The product allows two children to play at the same time - one can enjoy the rocking function with the small handlebar, while the other rides the classic Mini Micro Deluxe with the height-adjustable handlebar.

Parent-Friendly Design: Intuitive push bars and ergonomic features make handling a breeze.

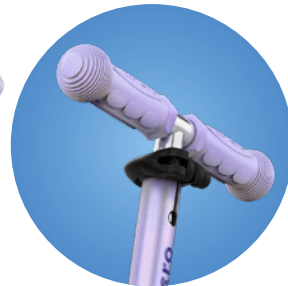

Built sustainably:

Durable materials designed for long-term use, reducing waste and maximizing value.



Keyless assembly, no tools required

1 - 6+ Years



2-3.1 kg (without rocker base)

1.8 kg (rocker base)



50 kg



1.



2.



3.



4.



5.



6.



MICRO MINI2GROW DELUXE MAGIC LED

All-in-one scooter for the first years of life

- Red MMD356
- Blue MMD0358
- Mint MMD0357
- Pink MMD0359



Multicolored LED light bulbs for more safety and driving fun

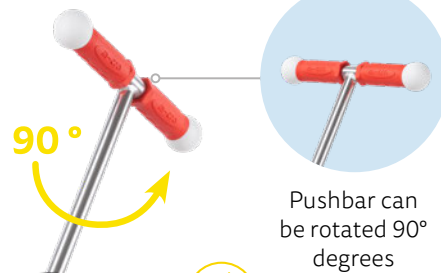

Keyless assembly, no tools required

Removable ergonomic seat



2 removable footrest options

LED moon wheels for better visibility

Lean-to-steer mechanism promotes balance and motor skills

1-6+ Years

2.2-3.5 kg

20 kg with seat
50 kg without



Grows with your child.



Check it out on YouTube

MICRO MINI2GROW DELUXE PLUS LED

The ultimate all-in-one scooter for early childhood adventures

- Olive Sage MMD0381
- Lavender Mist MMD0383
- Dusty Rose MMD0382
- Ocean Slate MMD0384

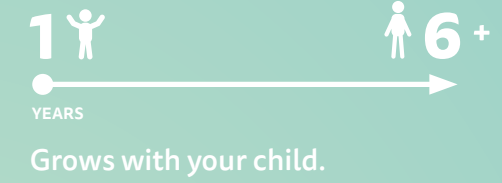

90°
Pushbar can be rotated 90° degrees

Keyless assembly, no tools required

4 Seat height options

Removable ergonomic seat, height-adjustable

LED moon wheels for better visibility

Removable footrest option

Lean-to-steer mechanism
promotes balance and motor skills

1-6+ Years

2.2-3.5 kg

20 kg with seat
50 kg without

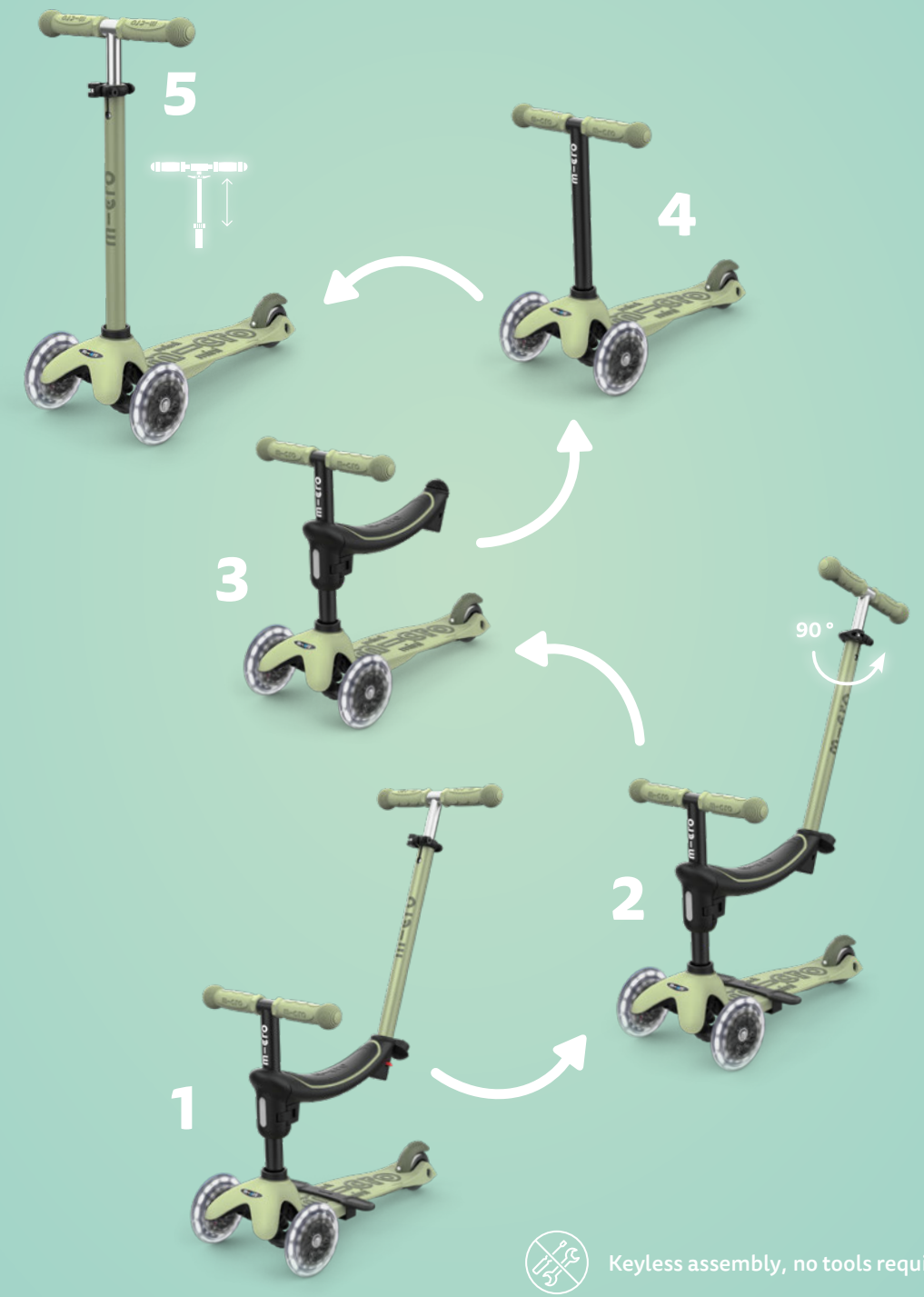

MINI MICRO 3IN1 DELUXE PLUS LED

Multifunctionality in perfection

Blue
MMD145

Pink
MMD146



MINI MICRO 3IN1 DELUXE PLUS

Everything from push along to pre-school scooter

- Pink MMD079
- Blue MMD080
- Ice Blue MMD057



1-5 Years

2-3.1 kg

20 kg with seat
50 kg without

MINI MICRO 3IN1 DELUXE

The transformation artist deluxe

- Pink MMD009
- Aqua MMD011
- Blue MMD014
- Purple MMD012
- Red MMD015



1-5 Years

2-2.2 kg

20 kg with seat
50 kg without



MINI MICRO 3IN1 DELUXE ECO LED

Multifunctional children's scooter made with recycled plastic components

NON-LED

- Green MMD161
- Mint MMD163
- Black MMD162

LED

- Green MMD167
- Mint MMD169
- Black MMD168



Height-adjustable handlebar

LED wheels for better visibility

Removable ergonomic seat



Anti-slip deck

Lean-to-steer mechanism promotes balance and motor skills

1 - 5 Years



1.95 - 2.2 kg



20 kg with seat
50 kg without



EXPLORING TODAY
PROTECTING
TOMORROW



MICRO MINI2GO DELUXE PLUS

Multi-tasking wonder, powered by parents

- Mint MMD031
- Red MMD032
- Pink MMD033
- Blue MMD034



2-5 Years 

1.9-4.2 kg 

20 kg with seat
50 kg without 



MICRO MINI2GO DELUXE

Open the drawer, store the toys and off you go!

- Mint MMD017
- Blue MMD030



2-5 Years 

1.9-3.6 kg 

20 kg with seat
50 kg without 





MICRO BALANCE BIKE LITE

The featherweight companion for the little ones

-  Chameleon Blue GB0034
-  Flamingo Pink GB0035
-  Peacock Green GB0036



- 2+ Years 
- 2.6 kg 
- 50 kg 



MICRO G-BIKE CHOPPER DELUXE

The perfect start to a life on two wheels

-  Pink GB0023
-  Aqua GB0025





Mudguard

Carving rear part for more stability

Foam tires for more comfort

Front suspension for bumpy adventures

- 2+ Years 
- 2.9 kg with carver 
2.5 kg without
- 20 kg 



MICRO TRAILER

Space for everything you need

● Black
AC0039



Compatible with all
Mini 3in1-, Mini2go- & G-Bike-Models

1.6 kg



10 l



MINI MICRO DELUXE FLUX LED

The coolest scooter for little tech fans!

- Red MMD206
- Yellow MMD202
- Neon Pink MMD203
- Neon Yellow MMD205
- Neon Green MMD201
- Navy MMD204



2-5 Years	
1.95 kg	
50 kg	



Mini Micro Deluxe Flux LED Red



Mini Micro Deluxe Flux LED Navy



Mini Micro Deluxe Flux LED Neon Yellow



Mini Micro Deluxe Flux LED Yellow



Mini Micro Deluxe Flux LED Green



Mini Micro Deluxe Flux LED Neon Pink



Check it out on YouTube

MINI MICRO DELUXE FLUX LED NEOCHROME

For young techies with a cool neochrome look!

- Pink MMD363
- Navy MMD364



2-5 Years	
1.95 kg	
50 kg	



MINI MICRO DELUXE GLITTER LED

For sparkling adventures

- Fairy Glitter Pink MMD208
- Fairy Glitter Purple MMD207
- Galaxy Glitter Navy MMD219



Check it out on YouTube

2-5 Years



2.1 kg



50 kg



MINI MICRO DELUXE GLOW LED

Safety plus fun factor

- Glacier Aqua MMD218
- Arctic Blue MMD216
- Frosty Pink MMD217
- Icy Lime MMD215

LED wheels
for better visibility

LED WHEELS

No batteries needed

Height-adjustable handlebar

Anti-slip surface

Deck, handles, brake and logo glow in the dark

Reinforced fiberglass footplate

Lean-to-steer mechanism
promotes balance & motor skills

Pastel look in daylight

Lights up in the dark

2-5 Years

2.1 kg

50 kg



Check it out on YouTube

MINI MICRO DELUXE GLOW LED PLUS

Magical glow, child's like joy

- Glacier Aqua MMD214
- Arctic Blue MMD211
- Frosty Pink MMD213
- Icy Lime MMD212



LED WHEELS
LED wheels for better visibility

No batteries needed

Height-adjustable handlebar

Anti-slip surface

Deck, handles, brake and logo glow in the dark

Reinforced fiberglass footplate

Lean-to-steer mechanism
promotes balance and motor skills

Additional luminosity thanks to motion-activated LED strips

Pastel look in daylight

Lights up in the dark

2-5 Years	
2.1 kg	
50 kg	



Check it out on YouTube



MINI MICRO DELUXE ECO LED

Children's scooter with components made from recycled fishing nets

- | | |
|--------------|--------------|
| LED | NON-LED |
| Green MMD164 | Green MMD119 |
| Black MMD165 | Black MMD157 |
| Mint MMD166 | Mint MMD158 |



LED wheels for better visibility

Height-adjustable handlebar

Anti-slip surface



Lean-to-steer mechanism promotes balance and motor skills

2-5 Years



1.95 kg



50 kg



EXPLORING TODAY PROTECTING TOMORROW m-ero



Check it out on YouTube

MINI MICRO DELUXE SMART

The Smart Micro Egg takes your scooter experience into the digital age!

 Aqua
MMD127

 Lavender
MMD126

 Navy Blue
MMD128



2-5 Years



1.95 kg



50 kg



INTERACTIVE SCOOTER GAME



Learn more about the Mini Micro Deluxe Smart



MINI MICRO DELUXE MAGIC

Magical driving fun on three wheels!

- Aqua MMD131
- Purple MMD129
- Pink MMD130
- Navy Blue MMD149



2-5 Years

2.1 kg

50 kg



Check it out on YouTube

MINI MICRO MINILINO

Mini Micro with Microlino Scooter Buddy

Red
MMD195



50 WHEELS

Detachable Microlino Scooter Buddy

Microlino toy with turning wheels

Height-adjustable handlebar

Anti-slip surface made of sandpaper

Reinforced fiberglass footplate

Lean-to-steer mechanism promotes balance and motor skills

2-5 Years



2.2 kg



50 kg



MINI MICRO DELUXE LED

Shine bright like a star!

- Green MMD051
- Yellow MMD053
- Blue MMD142
- Aqua MMD076
- Ocean Blue MMD152
- Navy Blue MMD118
- Purple/Pink MMD173
- Green/Blue MMD174
- Red MMD052
- Pink MMD075
- Purple MMD141
- Lavender MMD150
- Apricot MMD151
- Blue/White MMD176
- Crystal Blue MMD175



2-5 Years

1.95 kg

50 kg



MINI MICRO DELUXE

Everybody's favourite!

- Aqua MMD001
- Pink MMD003
- Yellow MMD005
- Red MMD007
- Lavender MMD037
- Turquoise MMD074
- Navy Blue MMD073
- Green MMD002
- Purple MMD004
- Blue MMD006
- Orange MMD008
- Ocean Blue MMD046
- Ice Blue MMD055



- 2-5 Years**
- 1.95 kg**
- 50 kg**



LAVENDER
MMD037



PURPLE
MMD004



ICE BLUE
MMD055



AQUA
MMD001



BLUE
MMD006



OCEAN BLUE
MMD046



YELLOW
MMD005



TURQUOISE
MMD074



ORANGE
MMD008



GREEN
MMD002



PINK
MMD003



RED
MMD007

MINI MICRO DELUXE FOLDABLE LED

The classic kids scooter even more compact!

- | LED | NON-LED |
|-------------------|-------------------|
| Ocean Blue MMD200 | Ruby Red MMD101 |
| Purple MMD199 | Pink MMD156 |
| Aqua MMD198 | Purple MMD153 |
| Pink MMD197 | Navy Blue MMD154 |
| Navy MMD196 | Ocean Blue MMD102 |
| | Aqua MMD155 |

LED wheels for better visibility

Simple folding mechanism

Reinforced fiberglass footplate

Height-adjustable handlebar

Lean-to-steer mechanism promotes balance and motor skills

2-5 Years	
2.1 kg	
50 kg	

MINI MICRO DELUXE FOLDABLE ECO LED

Green MMD222

1% FOR THE PLANET



LED wheels for better visibility

Simple folding mechanism

Height-adjustable handlebar

Lean-to-steer mechanism promotes balance and motor skills

RECYCLED FISHING NET DECK & BRAKE

2-5 Years	
2.1 kg	
50 kg	

MINI MICRO DELUXE FOLDABLE ORION LED

Shines bright like the stars!

- Blue MMD374
- Pink MMD373

Sunlight or UV-charged glowing handles

1

2

LED WHEELS

LED wheels for better visibility

Height-adjustable handlebar

Simple folding mechanism

No batteries needed

Sunlight or UV-charged glowing stars in the deck and brake—no batteries required

Lean-to-steer mechanism promotes balance and motor skills

2-5 Years	
2.1 kg	
50 kg	

Magic Glow Effect



MAXI MICRO DELUXE FLUX LED

The scooter for tech fans!

- Purple MMD121
- Aqua MMD138
- Blue MMD137
- Pink MMD139



5-12 Years	
2.5 kg	
50 kg	



Maxi Micro Deluxe Flux LED
Aqua



Maxi Micro Deluxe Flux LED
Pink



Maxi Micro Deluxe Flux LED
Purple



Maxi Micro Deluxe Flux LED
Blue

MAXI MICRO DELUXE FLUX LED NEOCHROME BLACK

Black
MMD209

The epitome of technological elegance!

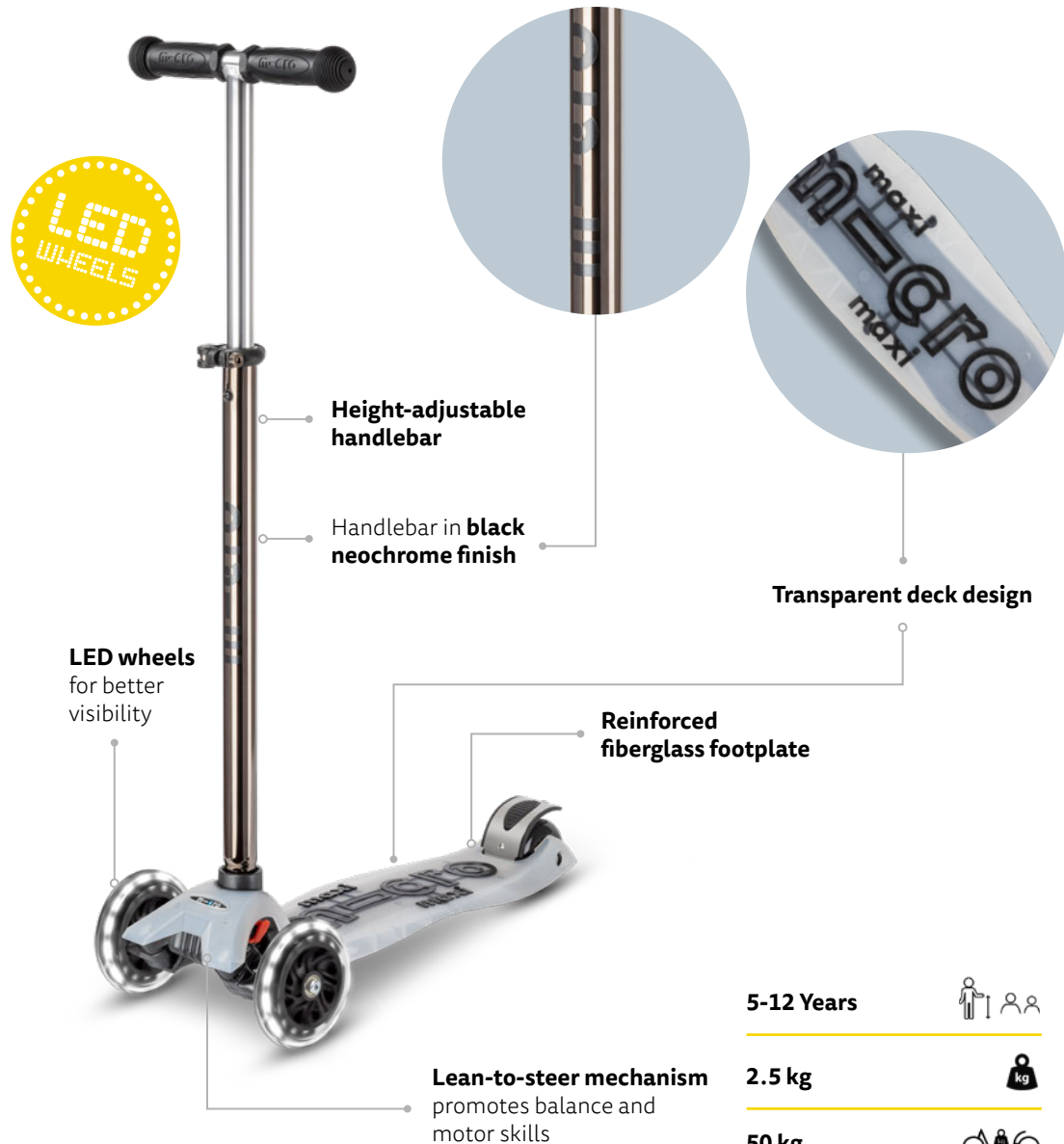

5-12 Years	
2.5 kg	
50 kg	



MAXI MICRO DELUXE GLOW LED

Experience the ultimate driving pleasure and radiance

- Jelly Green MMD365
- Bright Purple MMD367
- Crystal Blue MMD366
- Aura Red MMD368



5-12 Years 

2.5 kg 

50 kg 



MAXI MICRO DELUXE GLOW LED PLUS

Experience the ultimate driving pleasure and radiance

- Jelly Green MMD376
- Luminous Purple MMD378
- Crystal Blue MMD377
- Aura Red MMD379



5-12 Years	
2.5 kg	
50 kg	



MAXI MICRO DELUXE ECO LED

Children's scooter with components made from recycled fishing nets

LED

-  Green MMD170
-  Black/Grey MMD171
-  Mint MMD172

NON-LED

-  Green MMD122
-  Black/Grey MMD159
-  Mint MMD160



5-12 Years 

2.7 kg 

50 kg 



EXPLORING TODAY
PROTECTING
TOMORROW



Check it out on YouTube

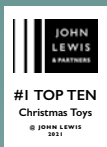

MAXI MICRO DELUXE FOLDABLE LED

Fold and go!

- Bright Blue MMD092
- Purple MMD100
- Volcano Grey MMD094
- Berry Red MMD095
- Shocking Pink MMD096
- Petrol Green MMD097
- Red MMD098
- Navy Blue MMD099
- Parrot Green (NEON) MMD229
- Navy/Red MMD133
- Ultra Pink (NEON) MMD228
- Blaze Orange (NEON) MMD227



5-12 Years	
2.8 kg	
50 kg	



MAXI MICRO DELUXE LED

Maximum luminosity on three wheels

-  Purple MMD066
-  Red MMD068
-  Aqua MMD078
-  Mint MMD144
-  Caribbean Blue MMD085
-  Navy/Red MMD133
-  Blue/White MMD132
-  Blue MMD067
-  Pink MMD077
-  Navy Blue MMD083
-  Black/Orange MMD143
-  Parrot Green (NEON) MMD232
-  Ultra Pink (NEON) MMD233
-  Blaze Orange (NEON) MMD231



- 5-12 Years 
- 2.5 kg 
- 50 kg 





MAXI MICRO DELUXE

Ride to school independently

-  Pink MMD021
-  Blue MMD023
-  Shocking Pink MMD035
-  Blue/White MMD132
-  Green MMD022
-  Yellow MMD024
-  Red MMD026
-  Lavender MMD134



- 5-12 Years 
- 2.5 kg 
- 50 kg 



MAXI MICRO DELUXE PRO LED

For the cool kickboarders

- Sunburst Yellow MMD041
- Vibrant Blue MMD042
- Rose MMD135
- Purple MMD043
- Black/Red MMD135
- Pink MMD040
- Navy/Red MMD044
- Olive Green MMD230



Lean-to-steer mechanism promotes balance and motor skills

5-12 Years

2.9 kg

50 kg



MAXI MICRO DELUXE PRO

Even more driving pleasure

-  Purple MMD091
-  Rose MMD090
-  Grey/Green MMD089
-  Grey/Aqua MMD088
-  Black/Red MMD087



Wide front wheels for more stability

Widely curved handlebar

Height-adjustable handlebar

Anti-slip surface

Reinforced fiberglass footplate

Lean-to-steer mechanism promotes balance and motor skills

5-12 Years 

2.9 kg 

50 kg 



MICRO CRUISER LED

Cruiser feeling with extra glow

- Blue SA0197
- Purple SA0251
- Pink SA0198
- Frosty Blue SA0256
- Aqua SA0199
- Berry Red SA0257
- Neochrome SA0240



5-12 Years	
4.5 kg	
100 kg	



MICRO CRUISER

For the ultimate cruiser experience!

- Blue SA0168
- Red SA0169
- Pink SA0170
- Black SA0201
- Purple SA0202
- Aqua SA0203



5-12 Years	
4.5 kg	
100 kg	



MICRO SPRITE DELUXE

Revival of a well-known classic

- Black
SA0200
- Neon Rose
SA0229
- Mint
SA0228



Kids & Teens 

3.3 kg 

100 kg 



MICRO SPRITE LED NEOCHROME BLACK

The timeless aluminum scooter with
a breathtaking black neochrome look

Black
SA0243



Kids & Teens	
3 kg	
100 kg	



MICRO SPRITE GLOW LED

Glowing fun on two wheels

White
SA0296



Special glow effect for increased safety and visibility in the dark

Foldable rubber handles



Compact & foldable

Kick-stand

LED moon wheels for better visibility



White color in daylight

Lights up in the dark

Kids & Teens



3.1 kg



100 kg



MICRO SPRITE ECO LED

Your contribution to a sustainable future on two wheels!

Green
SA0250



Sustainable folding handles made of cork



Laser engraved logo

Environmentally friendly water-based paint



Compact & foldable

All plastic parts are made from recycled fishing equipment (nets, ropes, etc.)

Kick-stand

LED wheels for better visibility

Kids & Teens



3.1 kg



100 kg



SUSTAINABLE CORK HANDLES



Check it out on YouTube



ECO-FRIENDLY LASERED LOGO



REPURPOSED FISHING GEAR COMPONENTS

Join us in preserving our oceans – every plastic part of the scooter, including the rims, is crafted from repurposed fishing equipment.



ENVIRONMENTALLY CONSCIOUS WATER-BASED PAINTING

MICRO SPRITE LED PEARL

The ultimate scooter for style-conscious adventurers!

- Blue Purple SA0293
- Green Purple SA0294



Kids & Teens

3.1 kg

100 kg



Check it out on YouTube

MICRO SPRITE LED

The classic aluminum scooter with extra sparkle

-  Silver Matt SA0216
-  Ocean Blue SA0210
-  Autumn Red SA0209
-  Forest Green SA0208
-  Pink SA0226
-  Blue Stripe SA0217
-  Black SA0225
-  Purple Stripe SA0219
-  Chartreuse SA0224
-  Petrol Stripe SA0218
-  Sapphire Blue SA0231
-  Neon Rose SA0235
-  Neochrome SA0237
-  Silverchrome SA0295



LED wheels for better visibility

Kids & Teens



2.9 kg



100 kg



MICRO SPRITE

The Classic

-  Silver Matt SA0019
-  Oasis Blue SA0024
-  Red SA0025
-  Black SA0026
-  Pink SA0027
-  Sapphire Blue SA0084
-  Black Stripe SA0133
-  Purple Stripe SA0137
-  Blue Stripe SA0177
-  Red Stripe SA0178
-  Petrol Stripe SA0179
-  Purple Metallic SA0132
-  Floral Dot Raspberry SA0136



Kids & Teens 

2.9 kg 

100 kg 



SCOOT YOUR COMMUTE

Micro Scooters not only make children's hearts beat faster, they are also very popular with adults. Perfect for short distances in town, such as from the train station to work or university, they can easily be combined with public transport. We have the right scooter for everyone, depending on their individual needs and intended use. Our product range extends from the compact Micro Speed to the high-end Micro Suspension with front and rear suspension. All our scooters have three things in common: functionality, attractive design and unmatched quality.

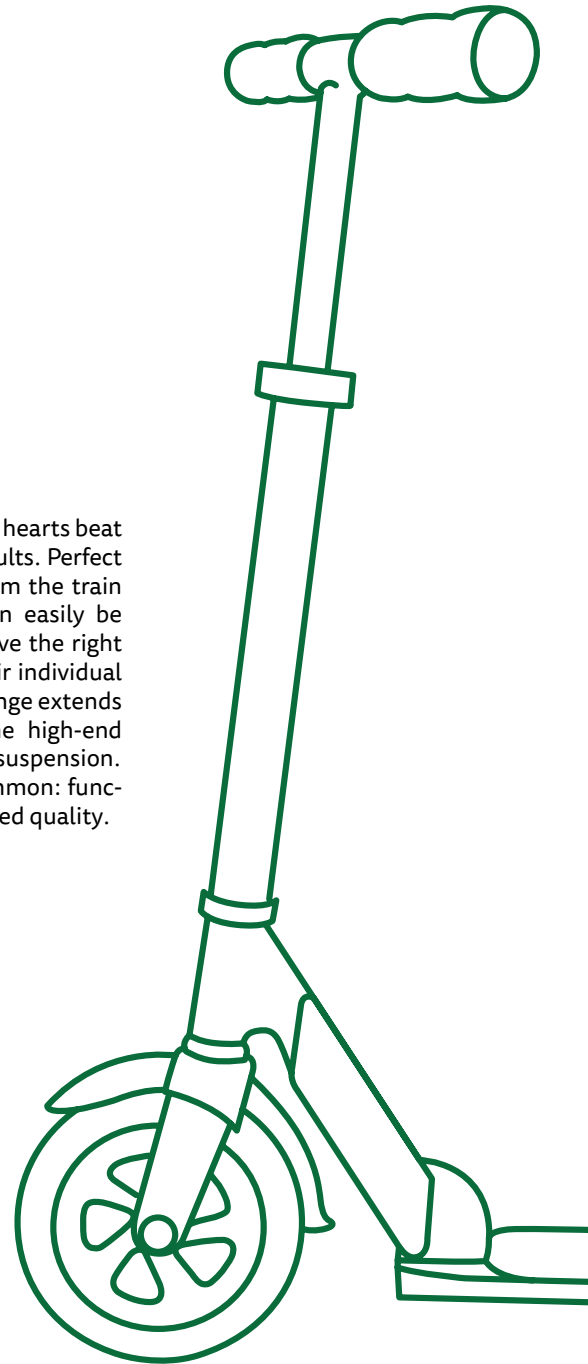

MICRO NAVIGATOR

State-of-the-art technology packaged in a timeless retro look!

Black/ Silver
SA0232



6.8 kg



100 kg



Check it out on YouTube

MICRO SPRITE SUSPENSION

The famous classic
with a new twist

- Dark Grey SA0245
- Light Blue SA0247
- Olive Green SA0246
- Pink SA0248



4.1 kg 

100 kg 



MICRO SUBURB RELOADED

Urban driving fun newly defined

Silver SA0249



6.2 kg



100 kg



MICRO METROPOLITAN DELUXE

The cozy allrounder

- Black SA0212
- Micro Metropolitan Deluxe Black (without handbrake) SA0188



MICRO SUSPENSION

No bumps, no shaking – just a smooth ride!

- Bronze SA0065
- Black SA0156
- Midnight Blue SA0297



200 mm wheels

6.1 kg



100 kg



MICRO CLASSIC NEOCHROME BLACK

The versatile urban companion in an elegant black neochrome look!

Black
SA0242



MICRO CLASSIC

A timeless companion for both him and her

-  White SA0031
-  Black SA0034
-  Neochrome SA0049
-  Matt Silver SA0241



200 mm wheels for more driving comfort

4.7 kg 

100 kg 

MICRO CLASSIC AIRLESS

Ride smooth, glide effortlessly

-  Midnight Grey SA0253
-  Pine Green SA0252
-  Peach SA0255



Shock-absorbing airless rubber tires, designed to provide a smooth & effortless ride

4.7 kg 

100 kg 

MICRO FLEX 200 MM

Comfortable driving fun

Black Matt SA0119



4.9 kg



100 kg



MICRO EAZY

Form follows function.
Foldable within a second!

Black
SA0155



Folded up, it can be pulled like a trolley

4.9 kg



100 kg



MICRO SPEED DELUXE

The discreet eye-catcher

- Clay SA0211
- Alaskan Blue SA0214
- Neon Rose SA0213







4.5 kg 

100 kg 



MICRO SPEED

The sprinter

-  Dolphin Grey SA0033
-  Aztec Black SA0121
-  Mint SA0122
-  Silver SA0142
-  Matt Neochrome SA0244



Shock-absorbing
145 mm wheels

Foldable

Kick-stand

3.8 kg



100 kg



Matt neochrome finish

MICRO ROCKET DELUXE

For downhill rides with style

● Neon Rose
SA0233

● Alaskan Blue
SA0234



4.3 kg



100 kg



Check it out on YouTube

MICRO ROCKET

The downhill specialist

Green
SA0032

Sky Blue
SA0143

Black
SA0048



3.9 kg



100 kg



MICRO KICKBOARD RELOADED

Cruising on three wheels

● Olive KB0027

● Plum KB0026

● Blue Berry KB0025



3.9 kg



100 kg



KICKBOARD ORIGINAL 2.0

Surf the sidewalks!

Alu
KB0024

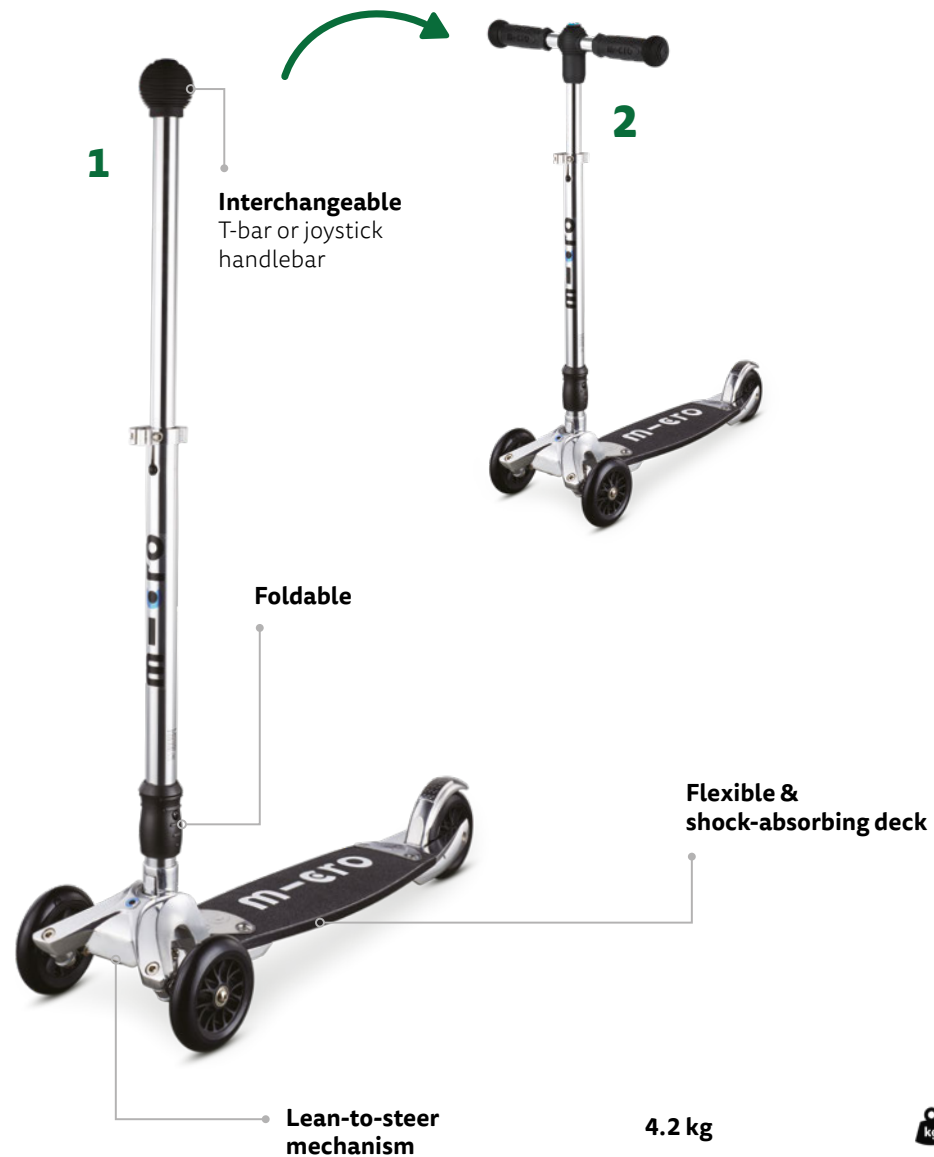

4.2 kg



100 kg



MICRO KICKBOARD MONSTER

The sleek monster

Black KB0022

Volcano Grey KB0023



5.3 kg 

100 kg 

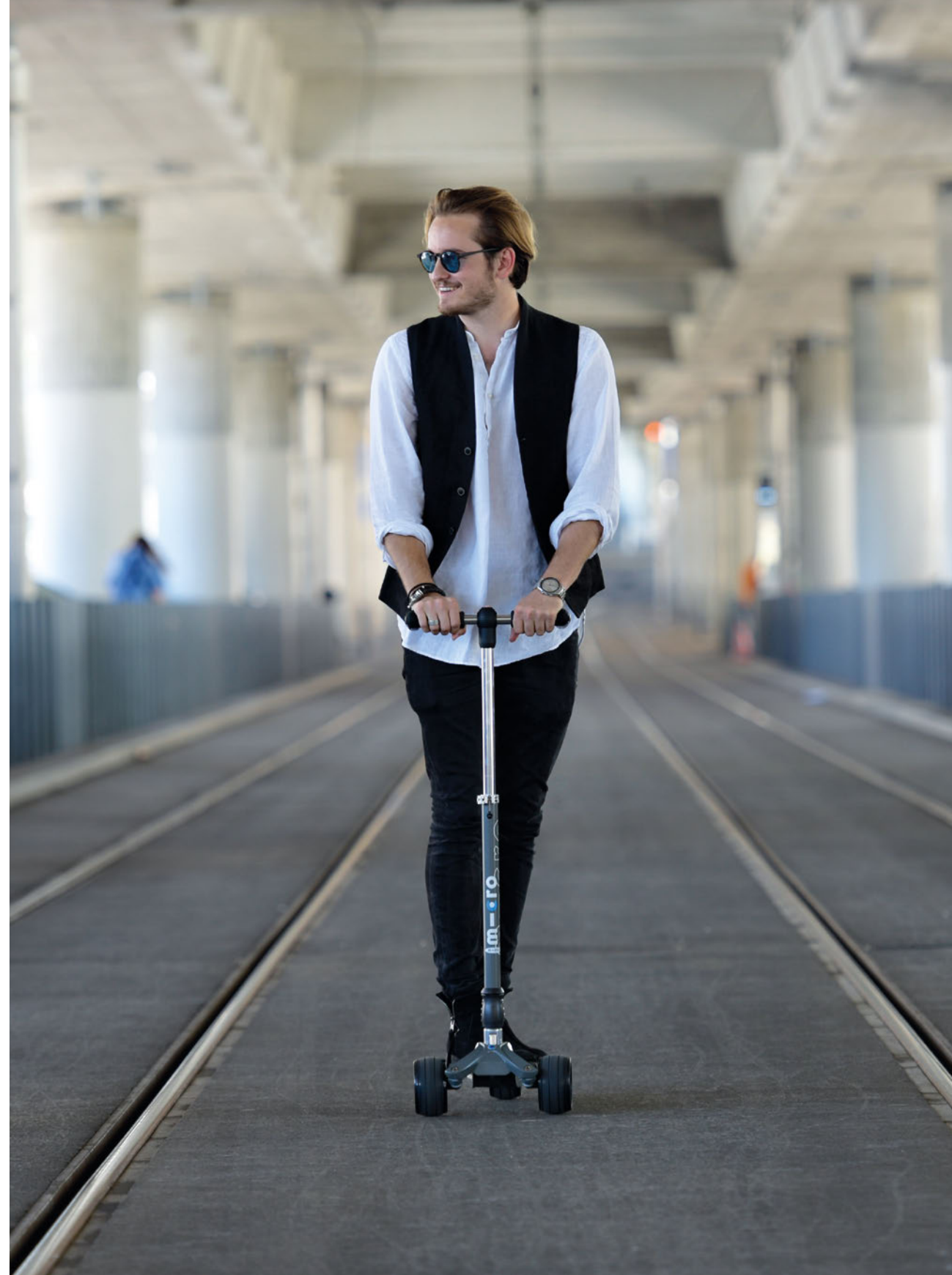

MICRO KICKBOARD COMPACT

Compact & agile, ideal for beginners!

○ Silver Matt KB0019

● Black Matt KB0020



4.4 kg 

100 kg 



MICRO PEDALFLOW

No time for the gym?
No problem!

○ White
CB0001

● Black
CB0002



8.3 kg 

100 kg 



reddot design award
honourable mention 2012



WE ARE ELECTRIC

More and more people live in cities. In many places, traffic is a daily challenge. Traffic jams and parking shortages are part of the everyday life. Air quality is increasingly deteriorating and noise levels are increasing. We really need to make a change in how we move around! True to our vision of a **"better urban lifestyle"**, we have set ourselves the goal of making inner-city mobility more practical and eco-friendly, without forgetting the fun factor. Our e-scooters are an efficient and flexible way to get around town and are therefore the perfect solution for the "last mile"! The uniqueness of our electric scooters results from the combination of the modern, compact design, light weight, high-tech materials used and the high performance. When developing products in Switzerland, we attach great importance to the seamless integration of the latest, high-quality drive technology.

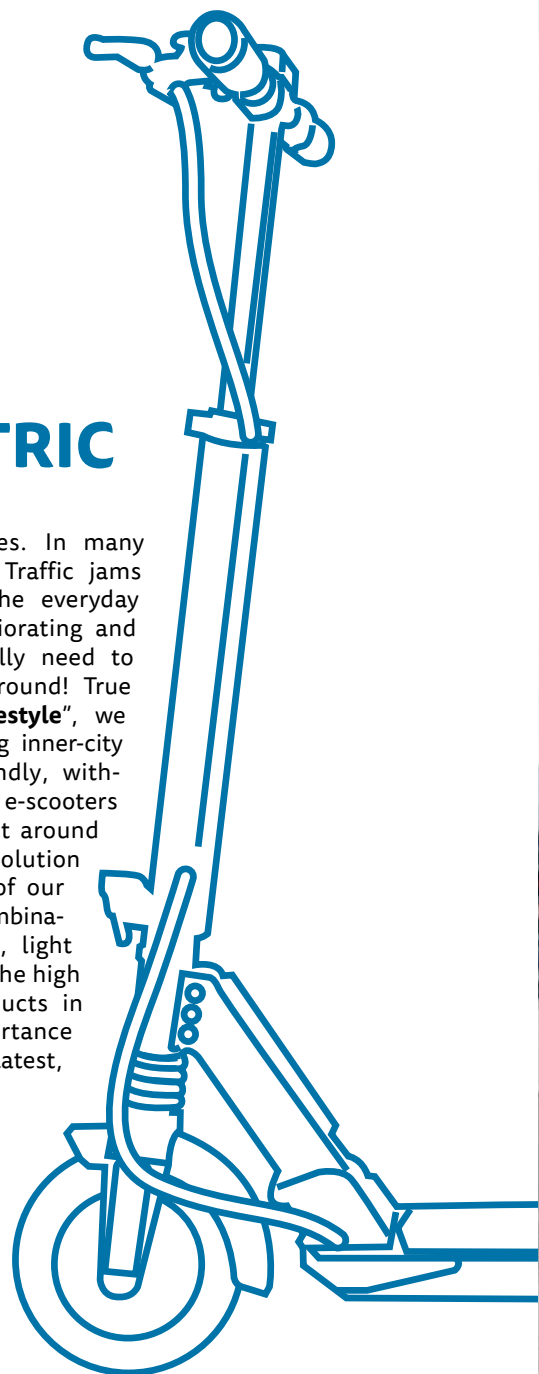

MICRO EXPLORER S

The ultimate powerhouse

- Silver
- EM0072 (25 km/h)
- EM0076 (20 km/h)



14 kg

Nom. 450 W
Max. 500 W

40 km

Twist throttle



MICRO EXPLORER II

Long lasting, powerful wide range

- Black
- EM0074 (25 km/h)
- EM0081 (20 km/h)



13 kg 

Nom. 350 W
Max. 500 W 

35 km 

Twist throttle 



MICRO MERLIN II

The spring loaded long distance runner

Black/Grey
EM0086 (25 km/h)
EM0092 (20 km/h)



13 kg	
nom. 300 W max. 500 W	
35 km	
Thumb throttle	



MICRO PREMIUM SERIES

The mobility solution for the last mile in your daily commute by train, tram, bus or car between home and office.



Micro Merlin II



Micro Explorer II



Micro Explorer S



Power	nom. 300 W max. 500 W	nom. 350 W max. 500 W	nom. 450 W max. 500 W
Range	35 km *	35 km *	40 km *
Torque	15 Nm	17 Nm	19 Nm
Hill climbing	15 %	16 %	20 %
Weight	13 kg	13 kg	14 kg

Braking systems	3	3	3
Tires	200 mm	200 mm	200 mm
App connectivity	no	yes	yes
Dual suspension	yes	yes	yes
Foldable handlebar & grips	yes	yes	yes
Display	yes	yes	yes

* ECO Mode



Micro Explorer S

MICRO X5

Effortless and reliable mobility

- Ice
EM0106 (20km/h)
EM0108 (25km/h)
- Midnight
EM0105 (20km/h)
EM0107 (25km/h)



19 kg	
nom. 300 W max. 500 W	
30 km	
Thumb throttle	



Check it out on YouTube

MICRO X11

Comfortable and efficient from A to B

Ice
EM0094 (20km/h)
EM0096 (25km/h)

Midnight
EM0095 (20km/h)
EM0097 (25km/h)



18.5 kg 

nom. 350 W
max. 500 W 

35 km 

Thumb throttle 



Check it out on YouTube



MICRO X30

The powerful long-distance runner

Ice
EM0098 (20km/h)
EM0100 (25km/h)

Midnight
EM0099 (20km/h)
EM0101 (25km/h)

Thumb throttle



Integrated Display

Two independent braking systems for absolute safety

Homologated front and rear lights

App-Connectivity



Electronic lock

Intuitive folding mechanism

Front suspension

Kick-stand

250mm rubber wheels

20 kg



nom. 500 W
max. 750 W



50 km



Thumb throttle



Check it out on YouTube

MICRO X RANGE

Designed for routes from A to B and longer journeys where comfort and stability are important, like on the way from home to the office, to university or on longer distances through the city



Micro X5



Micro X11



Micro X30



Power	nom. 300 W max. 500 W	nom. 350 W max. 500 W	nom. 500 W max. 750 W
Range	30 km *	35 km *	50 km *
Torque	18 Nm	23 Nm	29 Nm
Hill climbing	15 %	18 %	25 %
Weight	19 kg	18.5 kg	20 kg
Tires	250 mm	250 mm	250 mm
App connectivity ¹	yes	yes	yes
Front suspension	no	no	yes
Foldable	yes	yes	yes
Display	no	yes	yes



MICRO COMMUTER

Commuting has never been easier

Black/White
EM0085



- 10 kg 

- nom. 200 W
max. 250 W 

- 8 km 

- Twist throttle 



MICRO GLADIATOR

The powerful maneuvering pro!

Silver
EM0069



Front and rear suspension

Large footboard platform
for more stability and safety

20 kg



nom. 450 W
max. 500 W



Up to 80 km
(2 battery charges)



Twist throttle



RETHINKING URBAN MOBILITY

On average, cars carry just 1.2 passengers over a daily distance of 35 kilometers. It's a bit like lugging around a large suitcase every day, even though you're only taking a short trip—seems a bit excessive, doesn't it? That's where the Microlino comes in. It's perfect for the 95% of trips that don't require a big car, offering a smart balance between the comfort of a car and the agility of a motorcycle. Think of it as the iPad of mobility: compact, efficient, and just what you need. Plus, it's far more eco-friendly. Thanks to its lightweight design and minimal components, it consumes 60% less energy in both production and everyday use.

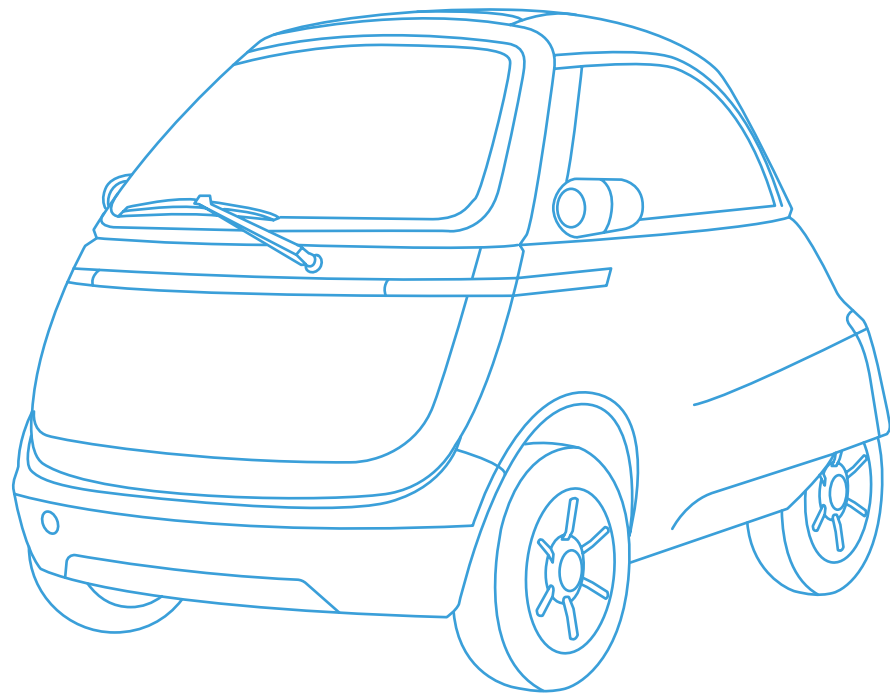

MICROLINO

This is not a car!

The Microlino is the iPad of the mobility world. It combines the advantages of a car with those of a motorcycle. We have equipped the Microlino with everything you need: space for two, three battery options and enough storage space for your shopping. Let's go!

-  Lite Venice Blue
-  Lite Berlin Anthracite Grey
-  Santorini White
-  Milano Red Monocolor
-  Gotham Black Matt
-  London Green Matt
-  Zurich Blue
-  Paris Mint
-  Milano Red
-  Spiaggina Sage
-  Spiaggina Portofino Blue



Lite, Venice Blue



Lite, Berlin Anthracite



Santorini White



Milano Red Monocolor



Gotham Black Matt



London Green Matt



Zurich Blue



Paris Mint



Milano Red



Spiaggina, Sage



Spiaggina, Portofino Blue

Range
93 km / 177 km / 228 km*

Battery
5.5 kWh / 10.5 kWh / 15 kWh

Top speed
90 km/h

Weight
435kg (excl. battery)

Power
12.4 kW



Learn more about the Microlino

Specifications are preliminary and subject to change at any time.

*Range according to WMTC measuring procedure (World Motorcycle Test Cycle - European standard). The WMTC specification is used to compare the vehicles. In practice, the range may differ significantly depending on riding style, load, topography and season.



PARKING

CROSS-PARKING RECOMMENDED

The Microlino can be parked sideways with a length of just 2.5 m. Thanks to the front door, you never have any problems getting out, because you step straight onto the sidewalk.



SUNROOF

HERE COMES THE SUN

The standard sliding roof ensures fresh air and a pleasant summer tan. Don't forget the sunscreen!

ENVIRONMENTALLY FRIENDLY

60% LESS ENERGY CONSUMPTION

With its lightweight design, the Microlino uses about 60% less energy in both production and operation compared to a typical electric car—not to mention the significant size difference when compared to a large combustion-engine SUV.



CHARGING

SOCKET-FRIENDLY

No special charger required! The Microlino can be charged easily and simply in just 4 hours using a normal socket.



TECHNICAL DATA

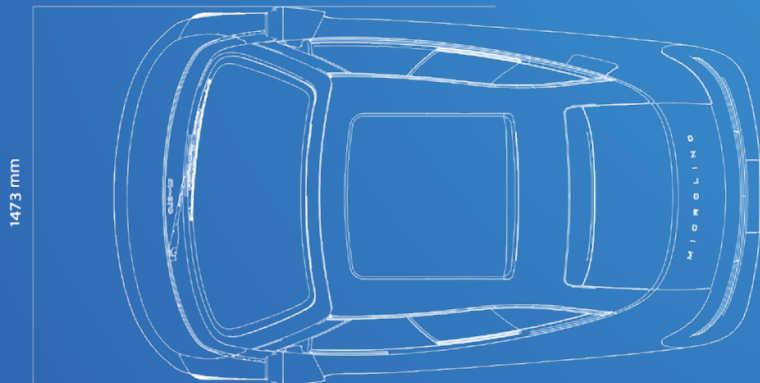
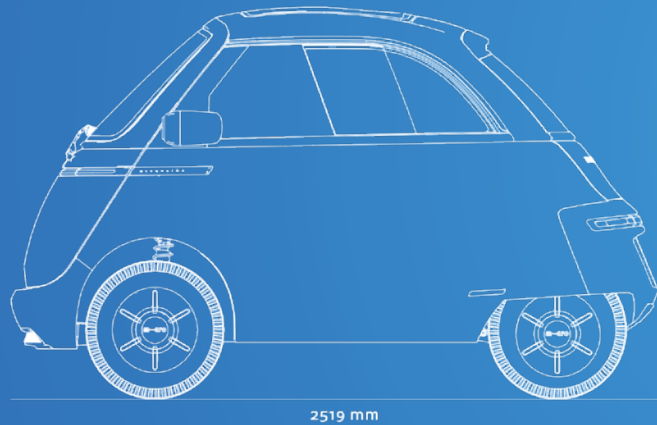
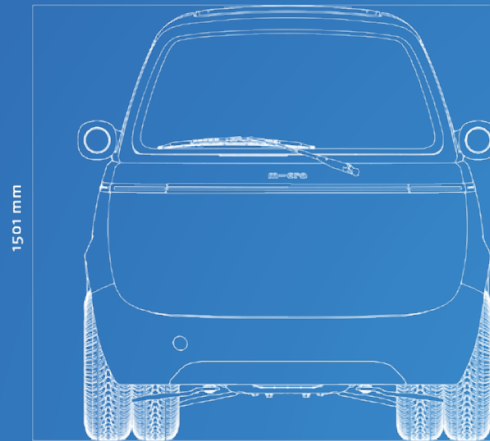

SHORT RANGE MEDIUM RANGE LONG RANGE

BATTERY & CHARGE	Version 45 / Version 90	Version 45 / Version 90	Version 90
Battery capacity (kWh)	5.5	10.5	15
Battery technology	Lithium-ion (NMC / NCA technology)		
Range (km) *	95 / 93	200 / 177	228
Charging time at household socket SOC 80% (h)	2	4	5.5
Charging power OBC (kW)	2.2		
MOTOR			
Power (kW)	6/12.4	6/12.4	12.4
Consumption (kWh)	6.8/7.3	6.8/7.3	7.3
DRIVING PERFORMANCE			
Acceleration 0-50 km/h (s)	5		
Maximum speed (km/h)	45/90	45/90	90
STEERING			
Turning circle (m)	7.4		
WEIGHTS (KG)			
Empty weight without battery (kg)	425/435	425/435	435
Empty weight incl. battery (kg)	576/586	605/615	629
Permissible total weight (kg)	750		
Payload (kg)	174/164	145/135	121
DIMENSIONS			
Length (mm)	2519		
Width (mm)	1473		
Height (mm)	1501		
Wheelbase (mm)	1566		
Front track (mm)	1255		
Rear track (mm)	935		
Trunk volume (l)	230		
Tire dimensions	145/70 R13 71 G		

Subject to alterations, errors and misprints

* Range according to WMTC measurement procedure (World Motorcycle Test Cycle - European standard). The WMTC specification is used to compare vehicles. In practice, the range may vary considerably depending on riding style, load, topography and time of year.

MICROLINO SPIAGGINA



MAX. SPEED
90 km/h



RANGE
177 km



CHARGING
ca. 4 hours



POWER
12.5 kW

PURE SUMMER FEELING

OPTIONALLY WITH REMOVABLE ROOF

Thanks to the open sides and the airy rear, the Spiaggina offers the ultimate summer experience – you can enjoy the fresh breeze while driving. The high-quality fabric roof can either be rolled back or removed completely in a few simple steps. More summer feeling is not possible! The interior in white-blue or gray-brown is made of special vegan leather, which is also used in sailing yachts and is particularly resistant to moisture.

www.microlino-car.com



Specifications are preliminary and subject to change at any time.

*Range according to WMTC measuring procedure (World Motorcycle Test Cycle - European standard). The WMTC specification is used to compare the vehicles. In practice, the range may differ significantly depending on riding style, load, topography and season.



MICROLINO

- LITE -

AM DRIVERS LICENSE

The Microlino Lite offers an unmatched driving experience in the L6e category (AM drivers license) and is redefining urban exploration at speeds up to 45 km/h.

With a generous seatbench, leaving space for two passengers and equipped with a trunk capable of fitting one large check-in and two cabin sized suitcases.



AUTOMOTIVE SAFETY CELL

SETTING A NEW STANDARD IN THE L6E CATEGORY

First in its class, the Microlino Lite features a self-supporting steel unibody that improves safety and driving behavior compared to the tubular frame of other vehicles in its class.

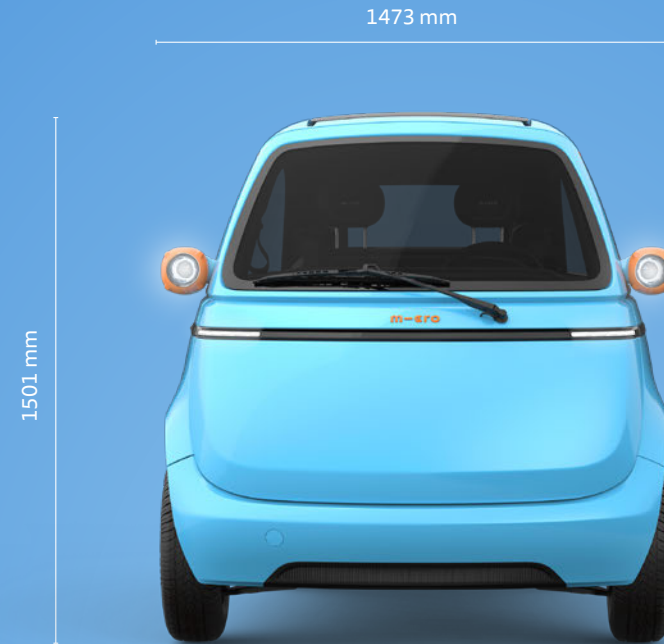

AM license
From the age of 14, depending on country.



MAX. SPEED
45 km/h



RANGE
95 km / 200 km



CHARGING
ca. 4 hours



POWER
12.5 kW



Specifications are preliminary and subject to change at any time.

*Range according to WMTC measuring procedure (World Motorcycle Test Cycle - European standard). The WMTC specification is used to compare the vehicles. In practice, the range may differ significantly depending on riding style, load, topography and season.



HAPPY TRAVEL!

In 2008, we entered the travel business and expanded our product range to include the Micro Luggage, a trolley case with an integrated kickboard, perfect for frequent flyers, travel enthusiasts and business people. A few years later, we received a surprising call from US DJ Steve Aoki, asking us to equip the Micro Luggage with a sound system. This is how the Micro Steve Aoki Luggage Sound2go with integrated Bluetooth sound box was created, designed by Steve Aoki himself. We have developed the Micro Trike and the Micro Luggage Eazy to cater for all age groups, especially the youngest. In line with Micro's guiding vision, our travel products offer practical, uncomplicated and unconventional mobility on the go.



MICRO TRICYCLE

Urban elegance, ultimate comfort: refined design, functional craftsmanship

Matcha TR0021

Latte TR0022



Easy handling and storage:
set up and dismantle in seconds



Removable roof

Hygienic: washable cushions

Backrest with two different positions (110 / 130 degrees)

Removable safety loop

180 degree rotating seat

Safety with 5-point belt

Pedals can be used in two different positions and are removable and lockable

6+ Months

8 kg

25 kg



The Micro Tricycle adapts perfectly to your child's growing needs.



MICRO BABY CRUISER 360°

Safety, comfort, style.
Our Baby Cruiser 360° makes every trip effortless!

● Matcha TR0023

● Latte TR0024



Removable, variable roof with UPF 50+ protection

Easy to fold set up and dismantle in seconds

Safety with 5-point belt

Hygienic antibacterial Ruco-Bac-Med pillow

No batteries needed

180 degree rotating seat

Dynamo powered front LED light

Foot brake

Easy maneuvering: 360° rotating front wheels

Storage space for essentials

6+ Months



7.3kg



15 kg



Baby chair for on the go: comfortable eating in the restaurant anytime and anywhere

Versatile seating options: Adjust the backrest to four different angles and use a 180° swivel seat for a variety of perspectives - effortlessly adapts to your child's needs.



Safety, comfort, style – Our Baby Cruiser 360 makes every journey effortless!

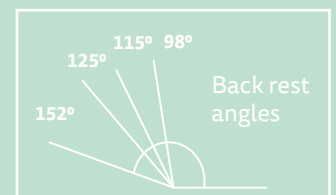

MICRO RIDE ON LUGGAGE EAZY ALLROUNDER

Let it be grocery shopping or travelling with kids, we got you!

-  Pink ML0040
-  Blue ML0041



18+ Months 

4 kg 

22 - 26 l 

20 kg 

MICRO RIDE ON LUGGAGE EAZY WEEKENDER

Forest Green ML0043

Weekend trip ahead?
We know the perfect companion!



Adjustable handle



Hand luggage compatible

(varies depending on airline)

Seat for kids

Folding wheels

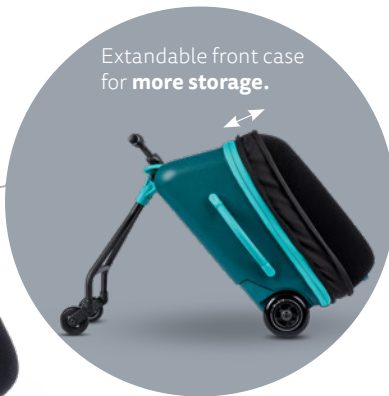

Extendable front case for more storage.



Front can be individually designed with patches

18+ Months



4 kg



22 - 26 l



20 kg



MICRO RIDE ON LUGGAGE EAZY WEEKENDER

Dark Blue ML0044

Your ultimate travel companion,
crafted for style & comfort every
mile of the way



Adjustable handle



Hand luggage compatible

(varies depending on airline)

Seat for kids

Folding wheels



Extendable front case for more storage.

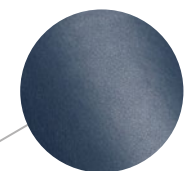

Front case made out of vegan leather

18+ Months



4 kg



22 - 26 l



20 kg



MICRO TRIKE XL

Ready, set – relax!

- Ruby Red TR0007
- Ice Blue TR0008
- Aqua TR0011
- Black TR0012
- Shocking Pink TR0013



18+ Months 

1.9 kg 

20 kg 



MICRO SCOOTER LUGGAGE JUNIOR PATCH & PLAY

The practical travel companion for the little ones

- Blue ML0036
- Pink ML0037
- Aqua ML0038



Customizable with patches

LED wheels for better visibility

Lean-to-steer mechanism

Storage space for little things

Height-adjustable handlebar



Hand luggage compatible (varies depending on airline)

Easily foldable

Push

Pull

2+ Years



3.3 kg



13 l



50 kg



Check it out on YouTube



MICRO SCOOTER LUGGAGE JUNIOR

The practical travel companion for the little ones

Mint ML0031

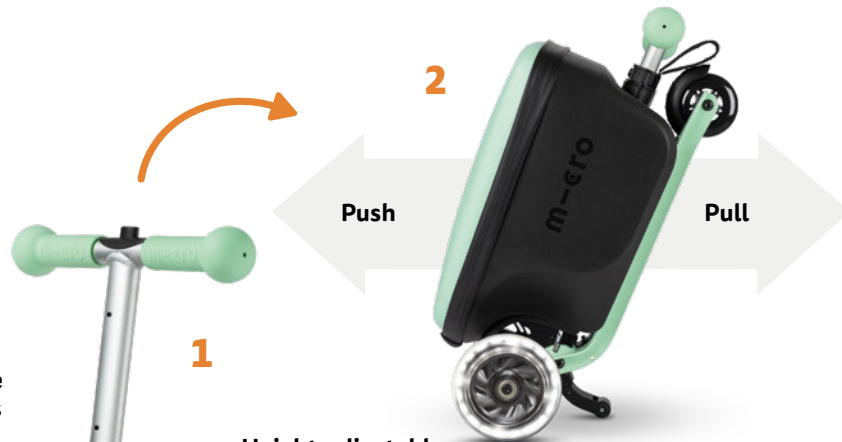

- Storage space for little things
- Height-adjustable handlebar
- Hand luggage compatible (varies depending on airline)
- Easily foldable
- LED wheels for better visibility
- Lean-to-steer mechanism

2+ Years	
3.3 kg	
13 l	
50 kg	



Check it out on YouTube



MICRO SCOOTER KICKPACK LITE 3.0

Black ML0039

Next generation backpack and scooter in one



Stylish backpack in faux leather, has lots of useful compartments

Height-adjustable handlebar

Trolley Mode
You can fold the deck up and use the Kickpack as a trolley



Hand luggage compatible
(varies depending on airline)



Easy Click System
Backpack easily clicks off the scooter base

Lean-to-steer mechanism

4.3 kg



19 l



100 kg



reddot design award winner 2010

MICRO SCOOTER LUGGAGE 4.0 S

Traveling has never been this easy

Grey
ML0047

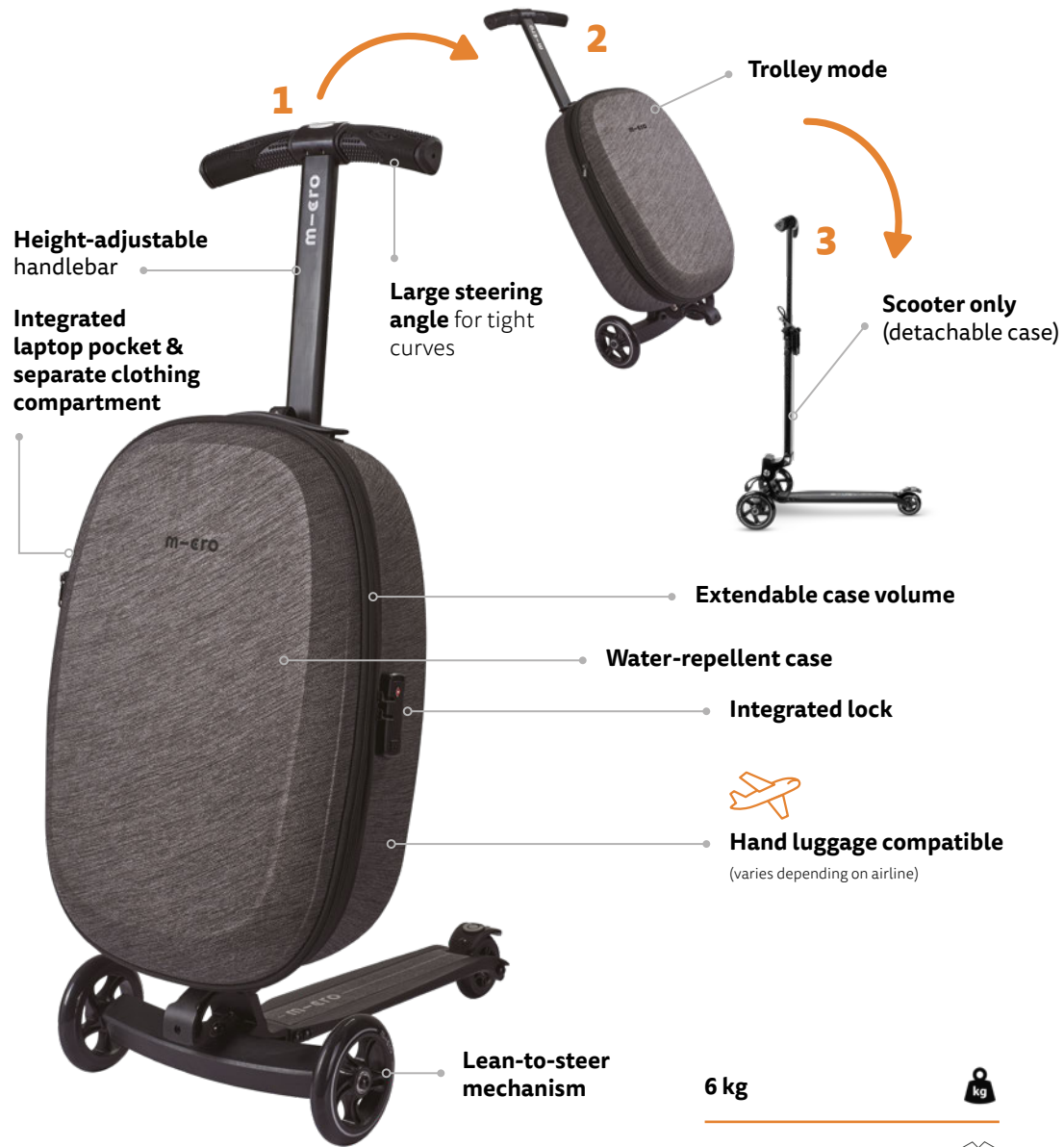

6 kg 

33-36 l 

100 kg 



MICRO SCOOTER LUGGAGE 4.0

Trolley and scooter in one

Black ML0025



6.1 kg



33 l



100 kg



reddot design award winner 2010

MICRO X STEVE AOKI LUGGAGE SOUND2GO

Rock the airports of the world!

Comic ML0007



MICRO WAGON CLASSIC

The family buddy

Black/Blue
MW0002



8.6 kg 

50 kg 

MICRO WAGON DELUXE PRO

The perfect companion for sunny days

Black/Blue
MW0004



12.5 kg 

50 kg 

FROM UNKNOWN SUBCULTURE TO TREND SPORT

What originated as an underground movement in the French-speaking region of Switzerland rapidly evolved into a global trend. A new sport has emerged, featuring a variety of breakneck tricks, including double backwards somersaults. Micro reacted immediately to this trend and developed the first stunt scooter together with riders from Montreux. The Micro freestyle scooters are generating great interest in the scene. The products' functionality, along with Micro's commitment to incorporating feedback and the needs of young drivers into new development processes, has contributed to this interest.

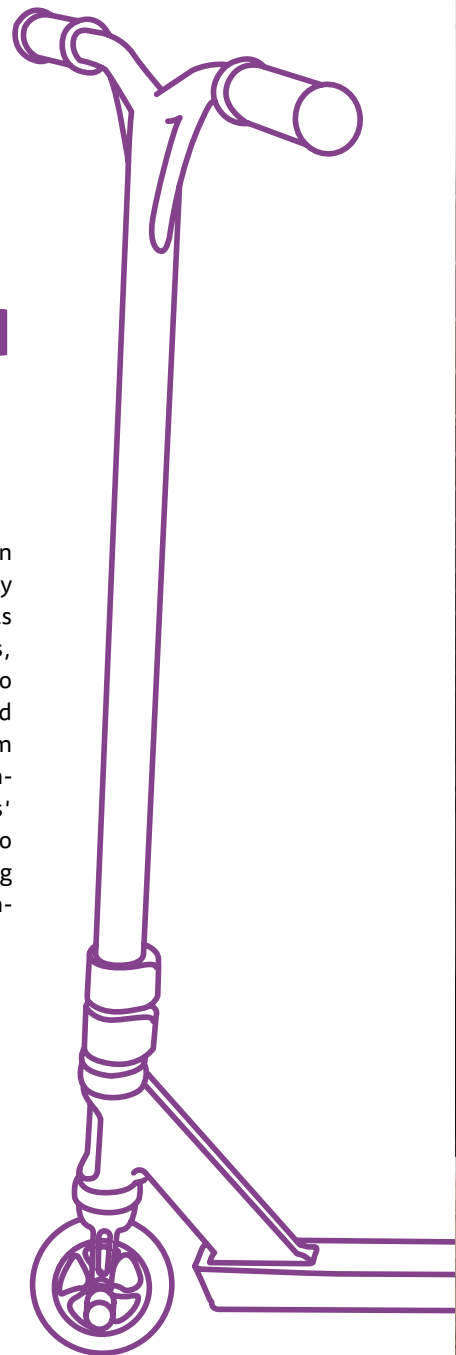

MICRO ICE SNOWPARK

The world's first snow park scooter!

Black SA0140



Wide, one-piece aluminum handlebar

Handcrafted vertical laminated wood core with fiberglass coating

Custom made with polyurea embedded rivets

Double metal runners for directional stability

5.9 kg



55 cm



86 cm



MICRO TROOPER

The street scooter for big stunt scooter fans

Black/Silver
SA0292



Hybrid Design:
Merges stunt scooter functionality with the practicality of a commuting scooter





Portable and Convenient: T-bar can be easily removed with an allen key for effortless commuting and traveling

Extra Large Wheels:
Equipped with 145 mm wheels, enabling speeds up to 30 km/h

Increased Height:
Overall scooter height of 98 cm for comfortable riding posture

Enhanced Safety:
Features a longer, heat-resistant brake for smooth and safe stopping

Tall Rider Friendly: Higher set-up and spacious deck cater specifically to taller riders

4.35 kg	
58 cm	
98 cm	
120 kg	









MICRO STUNT SCOOTER

Our three new stunt scooter models

- Maverick Grey SA0291
- Supreme Blue SA0290
- Genesis Mint SA0289



	Maverick	Genesis	Supreme	
Weight	3.6 kg	3.5 kg	3.35 kg	
Max. Load	100 kg	100 kg	100 kg	
T-Bar Width	80.5 cm	79.5 cm	91 cm	
T-Bar Height	58 cm	56.5 cm	66 cm	
Handlebar Material	Steel	Steel	Aluminum	
Deck Material	Aluminum	Aluminum	Aluminum	
Wheels	PU and metal core	PU and metal core	PU and metal core	





MICRO RAMP

The perfect scooter for the first tricks

- Black SA0190
- Cyan SA0192



100 mm metal core wheels

3.7 kg	
51 cm	
81.5 cm	
81.5°	



ACCESSORIES

ONLY THE BEST FOR YOU AND YOUR MICRO SCOOTER

Let your creativity run wild and give you and your Micro Scooter an individual look! Our huge selection of colorful and practical accessories ranges from helmets and lights to personal protective equipment and backpacks. Become part of the Micro Urban Lifestyle!



New



**Micro Bell Flux
Neon Green**
AC4730



**Micro Bell Flux
Neon Pink**
AC4717



**Micro Bell
Glitter Blue**
AC4735



**Micro Bell
Glitter Purple**
AC4736

New



Micro Dart Game
AC5481



**Micro Patches
Monsters**
AC4773



**Micro Patches
Mermaids**
AC4775



Micro Floor Light

AC5466 Micro Floor Light Unicorn
AC5468 Micro Floor Light Rocket

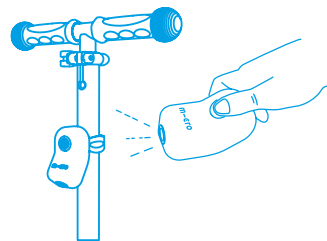

**Micro Scooter Buddy
Panda**
AC4769



**Micro Scooter Buddy
Flamingo**
AC4762



**Micro Scooter Buddy
Monsters**
AC4763



**Micro Scooter Buddy
Microlino**
AC4768



New



**Micro Pull & Carry Strap
Reflective Elastic
Black**
AC4840



**Micro Pull & Carry Strap
Reflective Elastic
Pink**
AC4841



**Micro Pull & Carry Strap
Reflective Elastic
Aqua**
AC4842

New



**Mandala Helmet
Neochrome Pink**
AC2285BX (S)
AC2286BX (M)



**Mandala Helmet
Neochrome Blue**
AC2287BX (S)
AC2288BX (M)



**Micro Bell
Neochrome Blue**
AC4715



**Micro Bell
Neochrome Purple**
AC4716



**Micro Knee and Elbow Pads
Reflective Blue**
AC5474 (S)
AC5475 (M)



**Micro Knee and Elbow Pads
Reflective Pink**
AC5476 (S)
AC5477 (M)



**Micro Knee and Elbow Pads
Reflective Black**
AC5472 (S)
AC5473 (M)



**Mandala Helmet
Green-Blue**
AC2280BX (M)



**Mandala Helmet
Pink-Purple**
AC2282BX (M)



Micro Mermaid Helmet
AC2283BX (S)
AC2284BX (M)



**Micro Cable Lock
Green**
AC4114



**Micro Cable Lock
Pink**
AC4115



**Micro Cable Lock
Black**
AC3001B



Counter Display
(without products)
DP0042



Get-the-Look Rocket



Micro Helmet Rocket
AC2100BX (XS)
AC2092BX (S)
AC2093BX (M)



Micro Knee and Elbow Pads Rocket (S)
AC8023



Micro Light Deluxe Rocket (V2)
AC4129



Micro Bell Rocket
AC4656



Micro Kids Metal Lock Blue
AC4111



Micro Gloves Rocket
AC4830



Micro Windmill Rocket (V2)
AC4750

Get-the-Look Unicorn



Micro Helmet Unicorn
AC2101BX (XS)
AC2102BX (S)
AC2103BX (M)



Micro Knee and Elbow Pads Unicorn (S)
AC8021



Micro Light Deluxe Dark Blue
AC4133



Micro Bell Unicorn
AC4655



Micro Kids Metal Lock Pink
AC4113



Micro Gloves Unicorn
AC4834



Micro Windmill Unicorn
AC4754

Get-the-Look Scootersaurus



Micro Helmet 3D Scootersaurus
AC2094BX (S)
AC2095BX (M)



Micro Knee and Elbow Pads Scootersaurus
AC8031



Micro Light Deluxe Dark Blue
AC4133



Micro Bell Scootersaurus (V2)
AC4647



Micro Kids Metal Lock Blue
AC4111

Get-the-Look Monsters



Micro Helmet 3D Monsters
AC2116BX (XS)
AC2117BX (S)
AC2118BX (M)



Micro Light Deluxe Red (V2)
AC4129



Micro Bell Monsters
AC4657



Micro Knee and Elbow Pads Monsters
AC8022 (S)

Get-the-Look Doodle Dot



Micro Helmet Doodle Dot
AC2098BX (XS)
AC2086BX (S)
AC2087BX (M)



Micro Light Deluxe Pink
AC4135



Micro Bell Pink
AC4651



Micro Kids Metal Lock Pink
AC4113



Micro Knee and Elbow Pads Doodle Dot
AC8020

Get-the-Look Flamingo



Micro Helmet Flamingo
AC2123BX (S)
AC2124BX (M)



Micro Light Deluxe Flamingo
AC4130



Micro Bell Flamingo
AC4648

Get-the-Look Floral Purple, Toucan, Dragon, Panda & Microlino



Micro Helmet Floral Purple
AC2137BX (S)
AC2138BX (M)



Micro Helmet Toucan
AC2099BX (S)
AC2125BX (M)



Micro Knee and Elbow Pads Reflective Pink
AC5476 (S)
AC5477 (M)



Micro Light Deluxe Purple
AC4134



Micro Bell Purple
AC4653



Micro Helmet 3D Dragon
AC2137BX (S)
AC2138BX (M)



Micro Helmet Microlino
AC2276BX (S)
AC2277BX (M)



Micro Helmet 3D Panda
AC2269BX (XS)
AC2270BX (S)
AC2271BX (M)

Neon Helmets



Micro Helmet Neon Pink S
AC2272BX



Micro Helmet Neon Blue S
AC2273BX



Micro Helmet Neon Green S
AC2274BX



Micro Helmet Neon Yellow S
AC2275BX

Sprite Uni Helmets



Micro Helmet Red
AC2108BX (S)
AC2109BX (M)



Micro Helmet Ocean Blue
AC2131 (M)



Micro Helmet Autumn Red
AC2129BX (M)



Micro Helmet Forest Green
AC2127BX (M)

Racing Helmets



Micro Helmet Racing White / Red
AC2133BX



Micro Helmet Racing White / Blue
AC2132BX

Youth Helmets



Micro Helmet Stickers
AC2120BX (M)
AC2121BX (L)



Micro Helmet Aqua
AC2115BX (M)



Micro Helmet Black
AC2096BX (M)
AC2097BX (L)



Micro Helmet Headphone Green
AC2111BX (M)



Micro Helmet Headphone Pink
AC2113BX (M)

Raspberry



Micro Helmet Raspberry
AC2080BX (S)
AC2081BX (M)



Micro Knee and Elbow Pads Reflective Pink
AC5476 (S)
AC5477 (M)



Micro Light Deluxe Pink
AC4135



Micro Kids Metal Lock Pink
AC4113



Micro Bell Pink
AC4651

Smart Helmet

Micro Smart Helmet
AC2134 (M)
AC2135 (L)



remote control

Black



Micro Helmet Black
AC2096BX (M)
AC2097BX (L)



Micro Light Deluxe Black
AC4132



Micro Bell Black
AC4652



Micro Cable Lock
AC3001B



Micro Bottle Holder Black (V2)
AC4694

Micro Knee and ElbowPads Reflective Black
AC5472 (S)
AC5473 (M)



Sunglasses



Micro Sunglasses Unicorn
AC5462



Micro Sunglasses Rocket
AC5461



Baskets



Micro Basket Green
AC4803



Micro Basket Rosa
AC4806



Micro Basket Pink
AC4804



Micro Basket Blue
AC4805

Ribbons



Micro Ribbons Blue Reflective
AC4629



Micro Ribbons Neon
AC4628



Micro Ribbons EasyShip Blue Reflective
AC4140



Micro Ribbons EasyShip Pink Reflective
AC4139

New



Micro Foldable Basket Unicorn
AC4807



Micro Foldable Basket Monsters
AC4808



Micro Foldable Basket Rocket
AC4809



Micro Foldable Basket Scootersaurus
AC4815



Micro Foldable Basket Black
AC4816



Additional accessories



Micro Helmet Visor
AC4138



Micro Carry Strap, Reflective
Purple: AC3039
Black: AC3041
Red: AC3036
Aqua: AC3037



Micro Bell Royal Blue
AC4658



Micro Bell Red (V2)
AC4650



Micro Bell Aqua (V2)
AC4649



Micro Trailer
AC0039



Micro Ball Net
AC9055



Micro Trike Net and Cupholder
AC8050



E-SCOOTER



Range



Motor power



Drive
(thumb throttle / twist throttle)

SCOOTER



Age range



Max. load



Handlebar height



Weight



Capacity



Handlebar width

















Angle



Wheels













AWARDS AND RECOGNITIONS





-  Oppenheim Toy Portfolio – Best Toy Award – Gold Seal
-  Oppenheim Toy Portfolio – Best Toy Award – Platinum
-  Australian Toy Association Award 2015 – Winner
-  Toy Award Nuremberg 2012 – Winner
-  Suisse Toy Award 2012 – Winner Babydreams
-  Reddot Design Award 2009 – Winner
-  Reddot Design Award 2010 – Winner
-  Reddot Design Award 2012 – Honourable Mention
-  Reddot Design Award 2014 – Winner
-  Parents Choice Approved
-  Little London Awards 2016 – Winner: Best Toy
-  Pro-K Product of the Year 2011 – Winner
-  German Design Award 2016 – Special Mention
-  LBP Loved by parents Winner Best Ride on 2011
-  Spiel Gut Award – Recommended



-  Das Goldene Schaukelpferd Nominated
-  Good Toy Award 2009 UK – Gold Award Winner
-  Toy Fair Award 2009 Middle East – Winner
-  Good Toy Award 2007 UK – Gold Award Winner
-  Universal Design Award 2009 Winner
-  Universal Design Award 2009 Consumer Favorite
-  Approuvé par les Familles 2014
-  iF Design Award 2002 – Winner
-  TCS Award 2015 Recommended
-  TCS Award 2015 Recommended
-  Focus Open 2016 Special Mention
-  German Design Award 2010 – Nominated
-  German Design Award Special Mention
-  German Design Award 2012 – Nominated
-  Nursery World Awards 2012 Shortlist

AWARDS AND RECOGNITIONS

-  Parent's Choice Award -Gold Award Winner
-  Finalist Lifestyle: Outdoor Gear
-  Winner Best Nuresy: Eco Toys
-  Focus Open 2020 Special Mention
-  German Design Award 2021 - Special Mention
-  German Innovation Award 2021 - Winner
-  Good Design Award 2020
-  Green Product Award 2021 Pre-Selection
-  Parents' Choice Recommended Award 2020
-  Red Dot Award - winner 2021
-  Top 10 Spielzeug 2021 - Nominated
-  Mums Choice Award Silver 2021
-  Mums Choice Award Bronze, 2021
-  Popsugar Family Awards 2021 Winner
-  Good Design Award 2021

-  Right Start Awards Highly Commended 2022
-  Green Good Design Award 2022
-  Project Baby - Toy Awards Gold, 2022
-  Junior Design Awards Gold, 2022
-  Made for Mums - Toy Awards Silver, 2022
-  Dadsnet - Awards Bronze, 2022
-  UKMUMS.TV Mum`s Choise Awards Bronze, 2022
-  UKMUMS.TV Mum`s Choise Awards Gold, 2022
-  Kind + Jugend Asean Innovation Award Winner, 2023
-  Go for Gold Silver Award 2023
-  The Travel Retail - Asia Pacific- Award Winner, 2023
-  Travel Retail Awards Highly Recommended by Shoppers - 2023

 facebook.com/micro.worldwide
 @microscooter_official
 @microoriginal
 @microscooter_official

 facebook.com/microlino.car
 @microlino_official
 @microlino_official
 @microlino_official

Micro Mobility Systems AG
 Bahnhofstrasse 10
 8700 Küsnacht
 Switzerland
 info@micro.ms
 www.micro-mobility.com
 www.microlino-car.com

IMPRINT

The name, logos and Micro products are protected by copyright and are trademarks of Micro Mobility Systems AG, Switzerland. All information in this catalog is without guarantee and replaces all content from previous years. Subject to change without notice.

CONCEPT

Jessica Stingl, Isabelle Ide, Janine Ouboter, Wim Ouboter, Merlin Ouboter, Oliver Ouboter
 Micro Mobility Systems AG

LAYOUT & DESIGN

Nikolett Palinkas & Livia Moor,
 Micro Mobility Systems AG

PHOTOS

Frank Nader
 Thomas Masotti
 Marty | Trezzini
 SCHAU
 Simon Habegger
 Serano Brazerol

PRINT

F&W Druck- und Mediencenter GmbH, Kienberg



Micro recommends wearing a helmet, as well as elbow and knee pads.

Copyright Year 2025
 All rights reserved.

FIND US WORLDWIDE

Find your local Micro representative





uptplatz

ab
SR/ML

m-ero

m-ero
Microlino

überparken

LEASE IT
NOW

This is not

m-ero

m-ero

m-ero



Micro Mobility Systems AG
Küsnacht, Zurich, Switzerland
www.micro-mobility.com